



Orthopädie, Osteosynthese  
Bone Surgery, Osteosynthesis  
Chirurgie osseuse, Ostéosynthèse  
Cirugía ósea, Osteosíntesis  
Chirurgia ossea, Osteosintesi

## Hohlmeißelzangen

Bone Rongeurs

Pinces-gouges

Pinzas-gubias

Pinze sgorbie

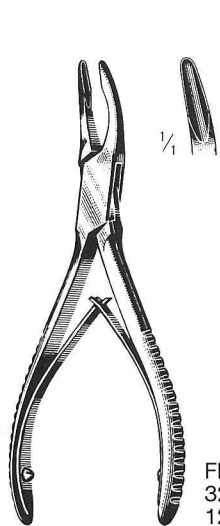

FRIEDMAN Mini  
32.101.12  
12 cm

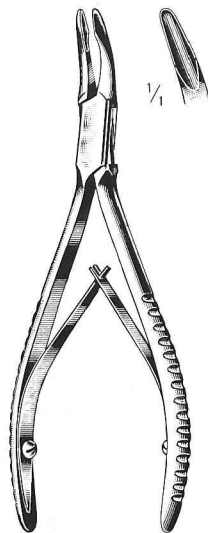

FRIEDMAN  
32.101.14  
14 cm

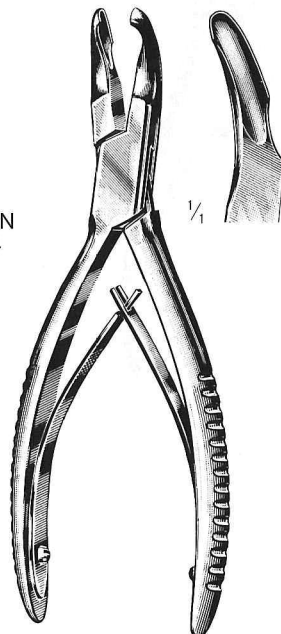

CLEVELAND  
32.105.17  
17 cm Fig. 4 A

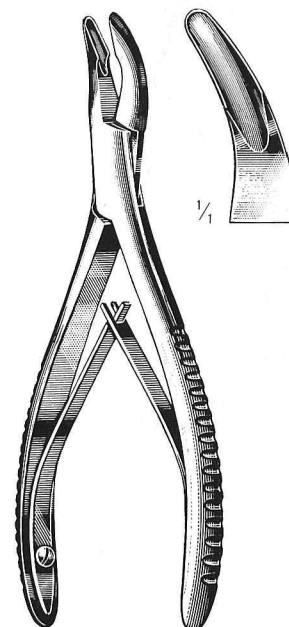

MEAD  
32.107.16  
16,5 cm Fig. 1 A

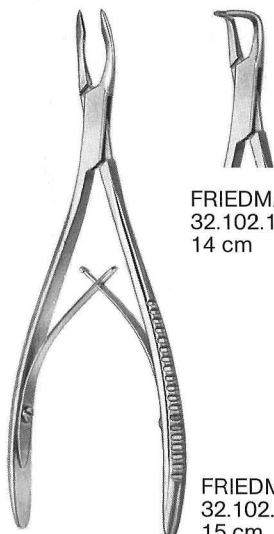

FRIEDMAN  
32.102.14  
14 cm

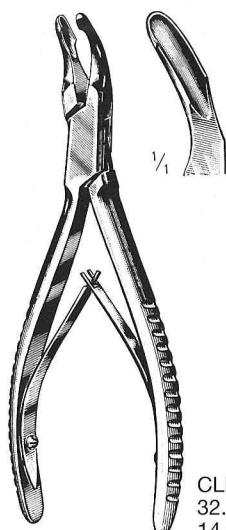

CLEVELAND  
32.103.14  
14 cm Fig. 4

FRIEDMAN  
32.102.15  
15 cm

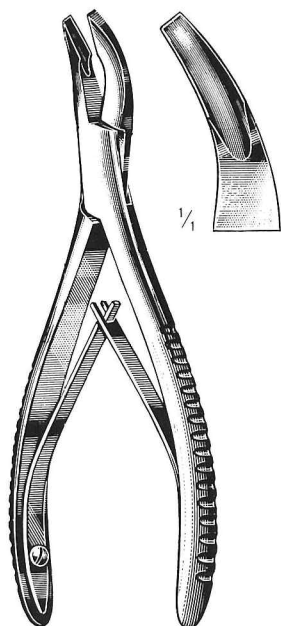

MEAD  
32.109.16  
16,5 cm

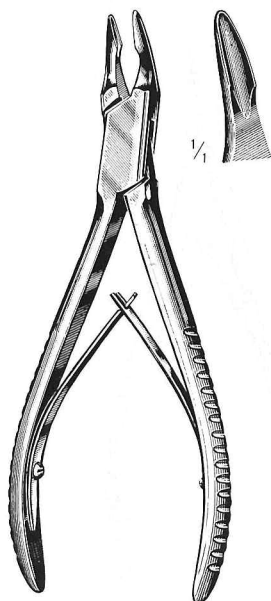

BLUMENTHAL  
32.115.15  
15,5 cm

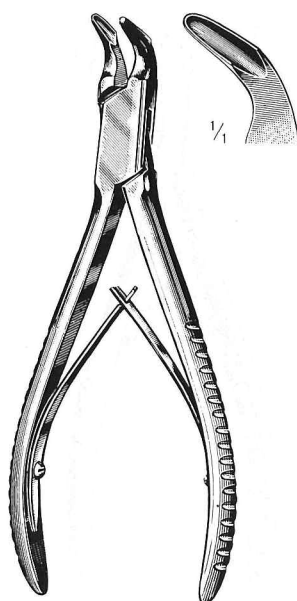

BLUMENTHAL  
32.117.15  
15,5 cm

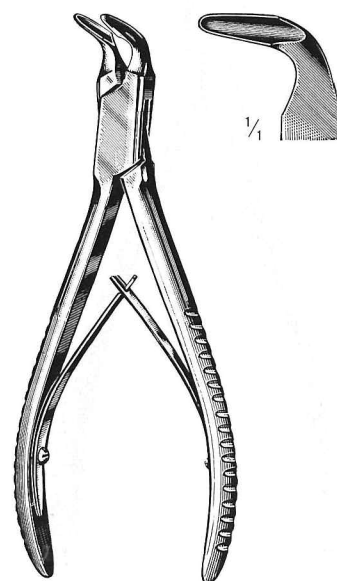

BLUMENTHAL  
32.119.15  
15,5 cm

**Hohlmeißelzangen**

Bone Rongeurs  
Pincas-gouges  
Pinzas-gubias  
Pinze sgorbie

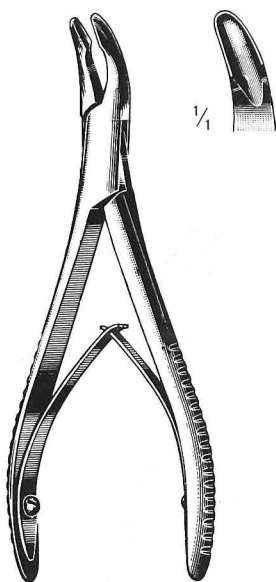

LUER  
32.131.15  
15 cm

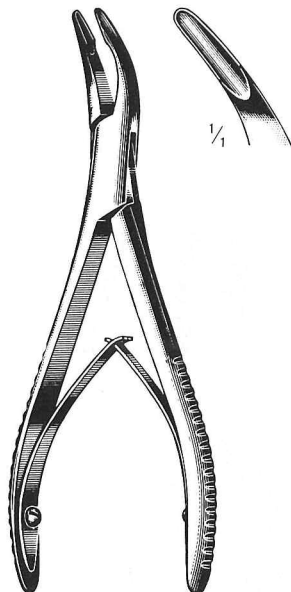

LUER  
32.133.15  
15 cm

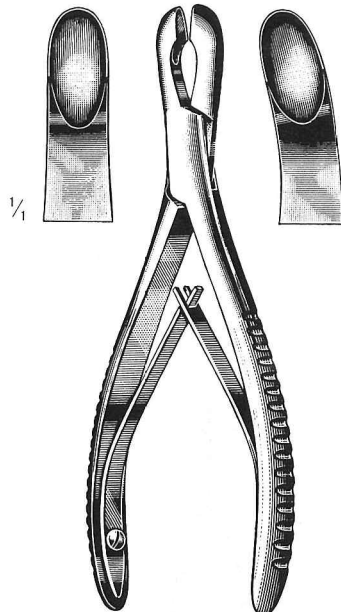

LUER  
32.136.17 17 cm 32.137.17

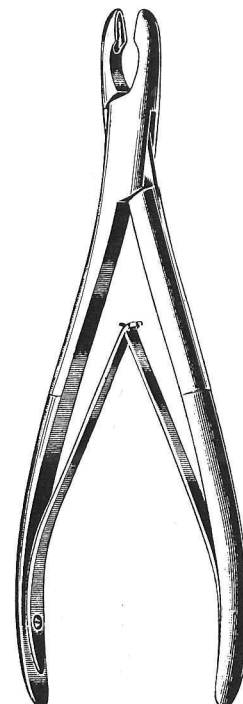

ADSON  
32.142.20 20 cm 32.143.20

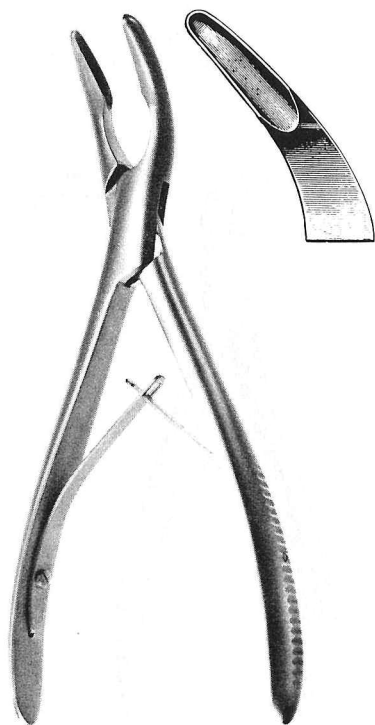

OLIVECRONA  
32.147.20  
20 cm

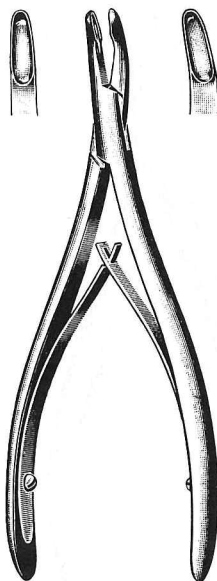

LEMPERT  
32.150.16 16 cm 32.151.16

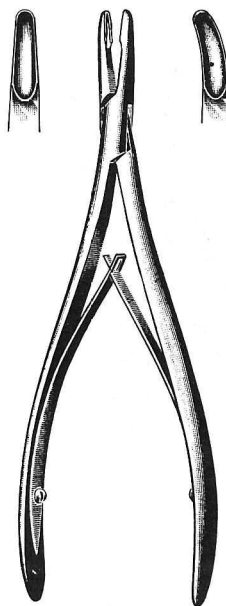

LEMPERT  
32.154.18 18,5cm 32.155.18

## Hohlmeißelzangen

Bone Rongeurs  
Pincès-gouges  
Pinzas-gubias  
Pinze sgorbie

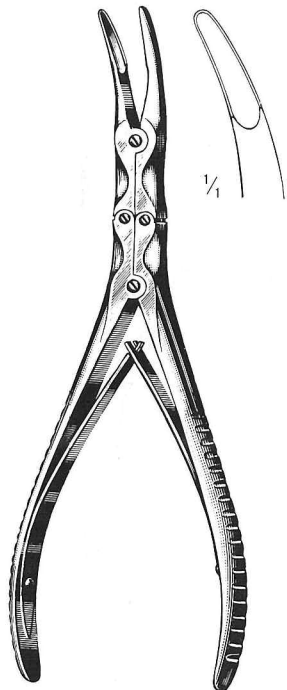

BEYER  
32.201.18  
18 cm

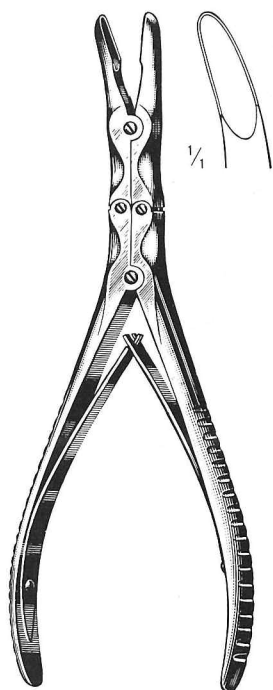

ZUFAL-JANSEN  
32.205.18  
18 cm

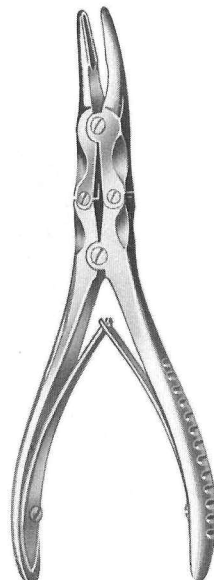

BÖHLER  
32.210.15 15 cm/2 mm 32.211.15  
32.212.15 15 cm/3 mm 32.213.15

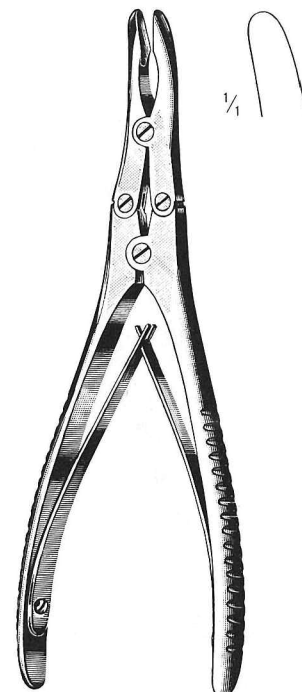

RUSKIN  
32.216.18 18 cm 32.217.18

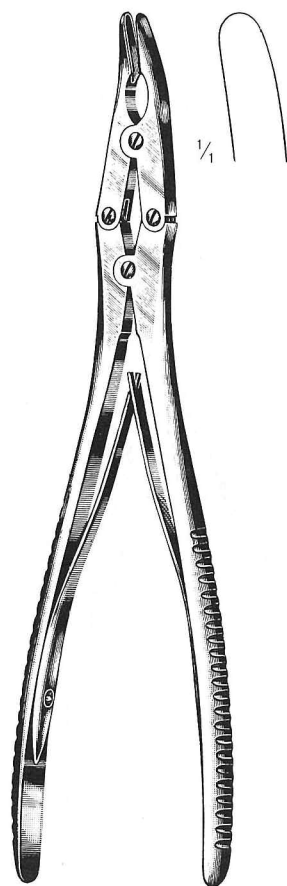

RUSKIN  
32.218.23 23 cm 32.219.23

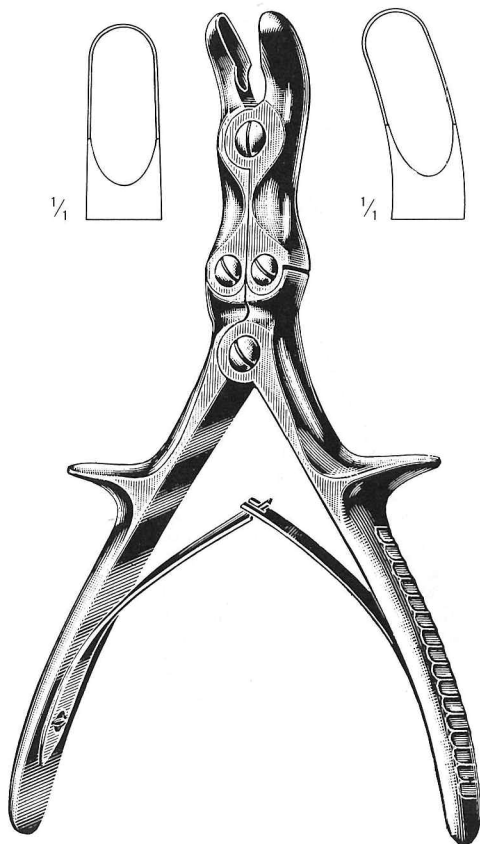

STILLE-LUER  
22 cm 32.231.22  
32.230.26 26 cm 32.231.26

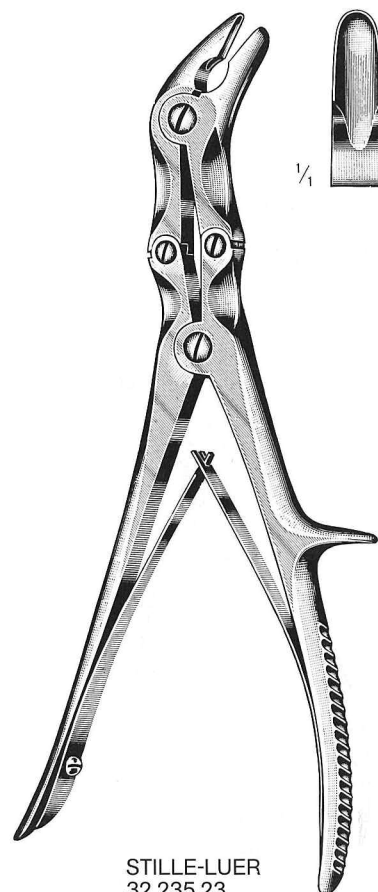

STILLE-LUER  
32.235.23  
23 cm

**Hohlmeißelzangen**

Bone Rongeurs  
Pincas-gouges  
Pinzas-gubias  
Pinze sgorbie

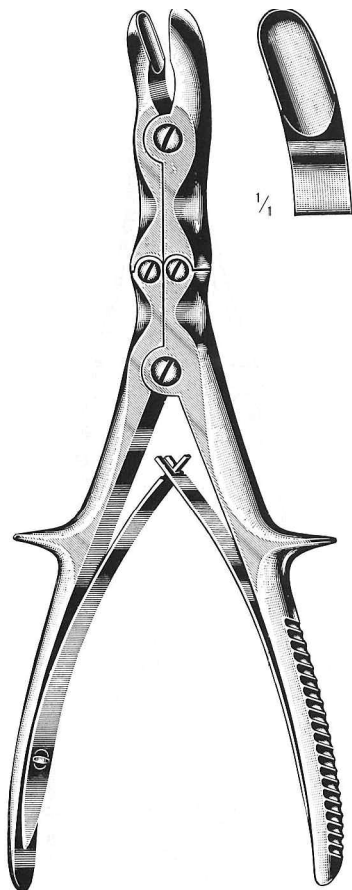

STILLE-RUSKIN  
32.237.23  
23 cm

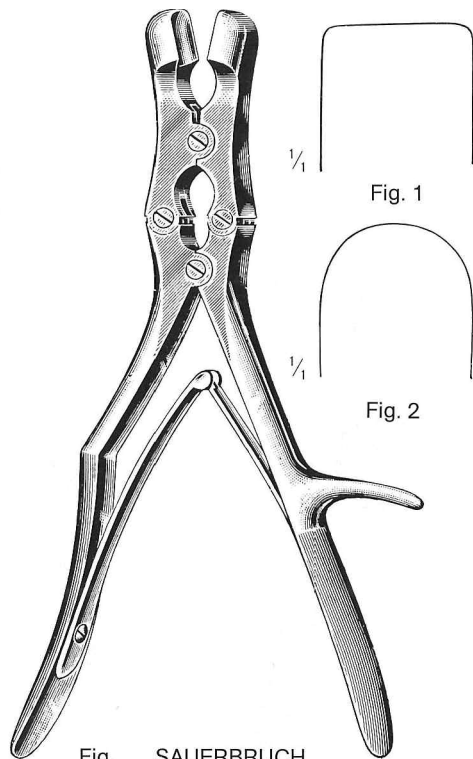

Fig. SAUERBRUCH  
1 32.241.30  
2 32.243.30  
30 cm

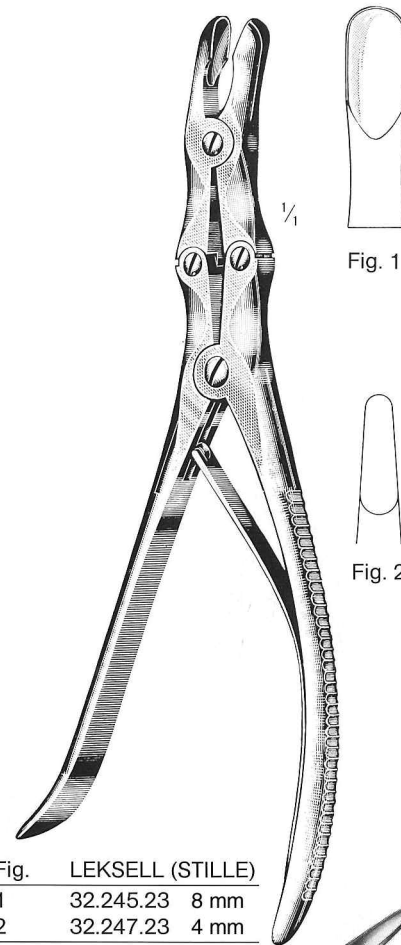
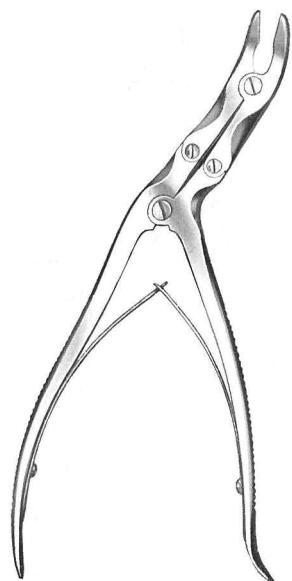

Fig. LEKSELL (STILLE)  
1 32.245.23 8 mm  
2 32.247.23 4 mm  
23 cm



R	SCAGLIETTI	L
32.251.26	26 cm	32.253.26
à droite		à gauche
derecha		izquierda
a destra		a sinistra



FRYKHOLM  
32.255.24  
24 cm



mm	ECHLIN
2	32.259.02
3	32.259.03
4	32.259.23
	23 cm

## Knochensplitterzangen

Bone Cutting Forceps

Pinces coupantes à os

Pinzas cortantes para huesos

Cesoie per ossa

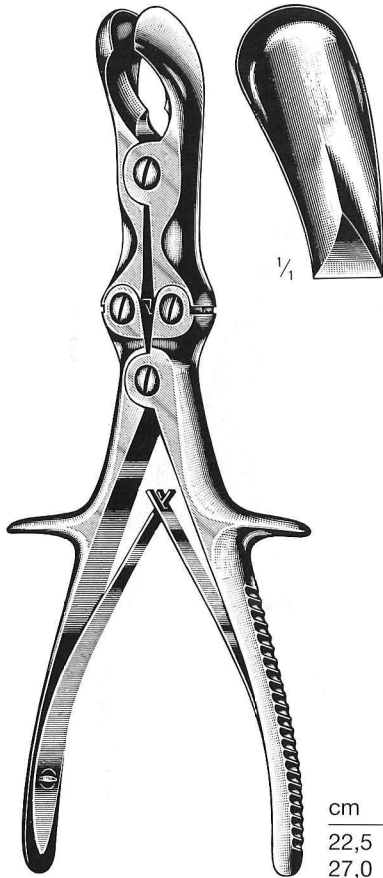

cm	SEMB
22,5	32.261.22
27,0	32.261.27

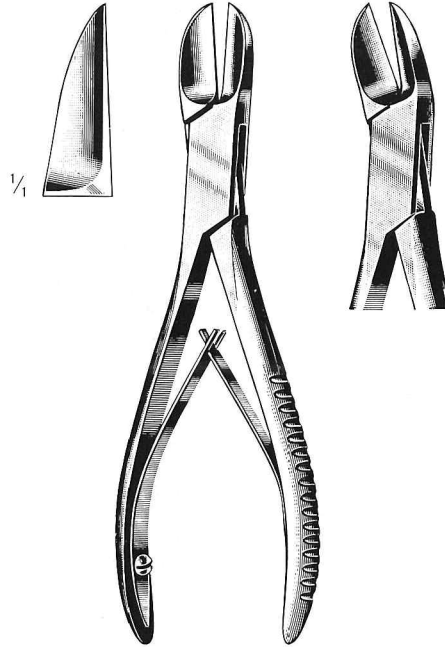

LISTON		
32.274.14	14 cm	32.275.14
32.274.17	17 cm	32.275.17
32.274.19	19 cm	32.275.19
32.274.22	22 cm	32.275.22

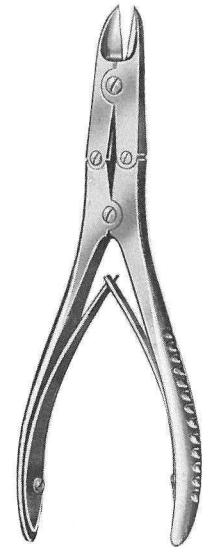

BÖHLER		
32.280.15	15 cm	32.281.15

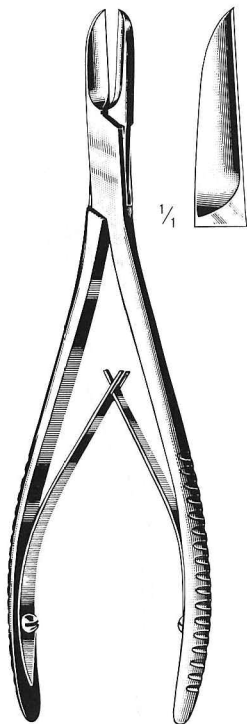

COTTLE-KAZANJIAN  
32.282.19  
19 cm

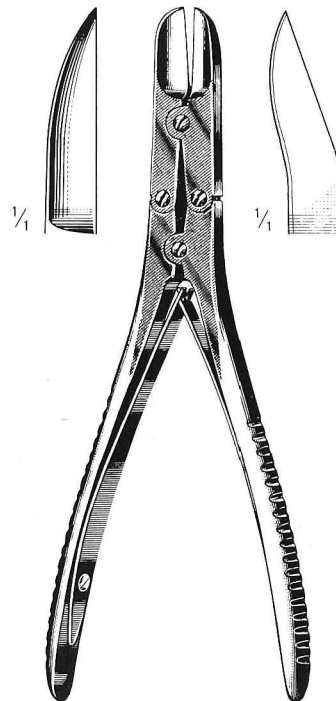

RUSKIN-LISTON		
32.286.18	18,5cm	32.289.18

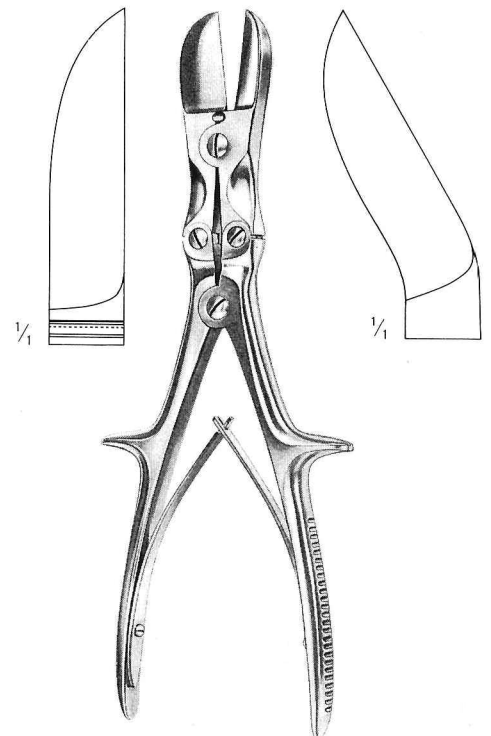

STILLE-LISTON		
32.290.27	27 cm	32.291.27

**Knochensplitterzangen**

Bone Cutting Forceps  
 Pinces coupantes à os  
 Pinzas cortantes para huesos  
 Cesioie per ossa

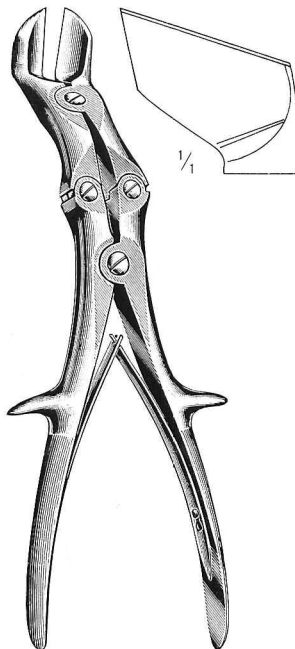

STILLE-HORSLEY  
 32.293.27  
 27 cm

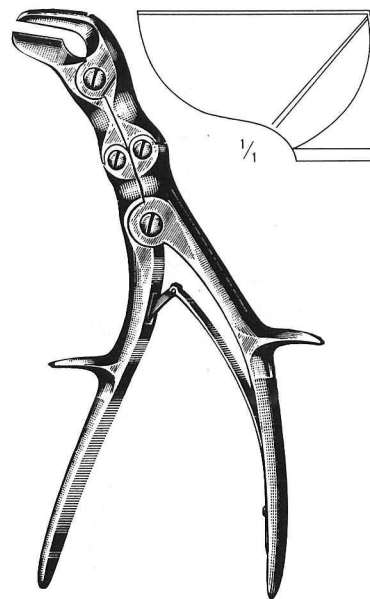

SEMB  
 32.295.24  
 24 cm

Knochenhalte-zangen  
 Bone Holding Forceps  
 Daviers porte-os  
 Pinzas para huesos  
 Tenaglie per ossa

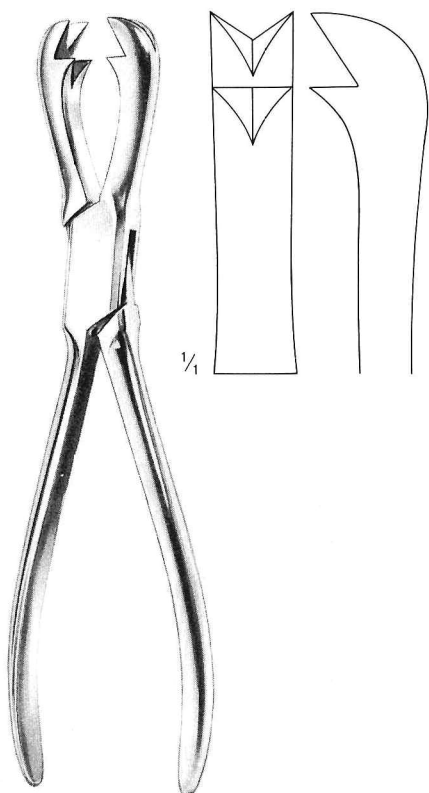

FERGUSON  
 32.360.21  
 21 cm

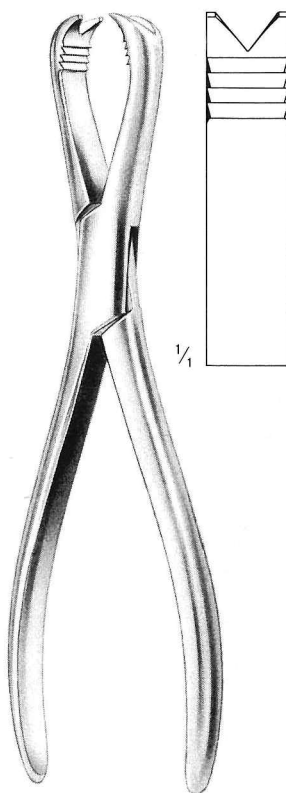

LANGENBECK  
 32.362.21  
 21 cm

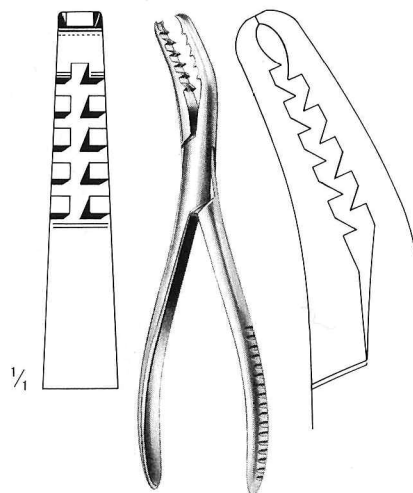

SEMB  
 32.365.19  
 19 cm

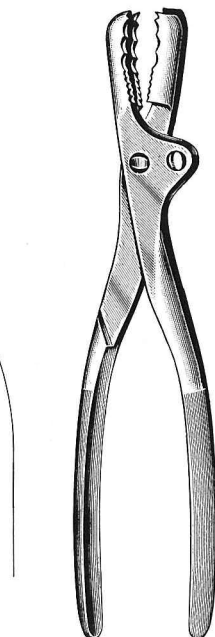

cm FARABEU  
 23 32.366.23  
 26 32.366.26

Orthopädie, Osteosynthese / Bone Surgery, Osteosynthesis / Chirurgie osseuse, Ostéosynthèse / Chirurgia ósea, Osteosíntesis / Chirurgia ossea, Osteosintesi

## Knochenhaltezangen

Bone Holding Forceps

Daviers porte os

Pinzas para huesos

Tenaglie per ossa

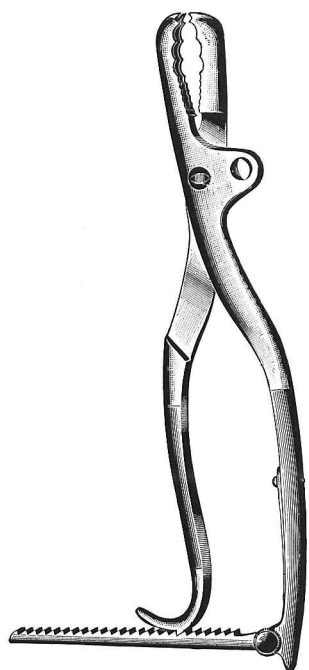

FARABEU-F-LAMBOTTE  
32.368.26  
26 cm

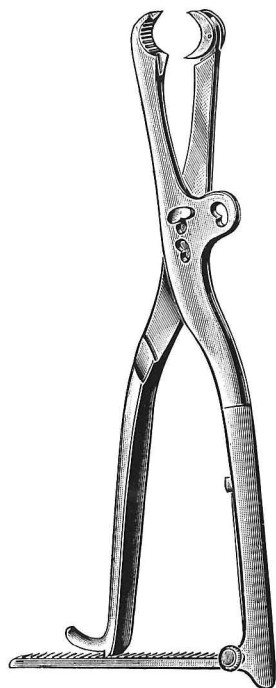

cm	LAMBOTTE
22	32.370.22
27	32.370.27
30	32.370.30

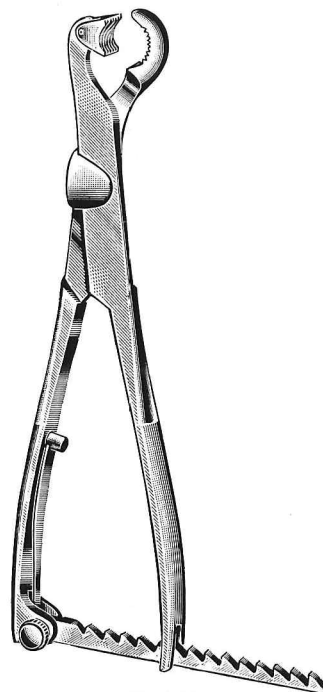

cm	LAMBOTTE
22	32.372.22
26	32.372.26
33	32.372.33



cm	LAMBOTTE
19	32.373.19
23	32.373.23
26	32.373.26

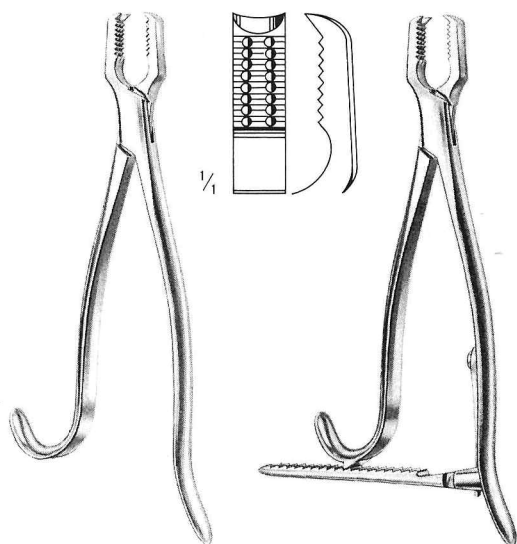

cm	KERN	KERN
15	32.378.15	32.380.15
17	32.378.17	32.380.17
21	32.378.21	32.380.21

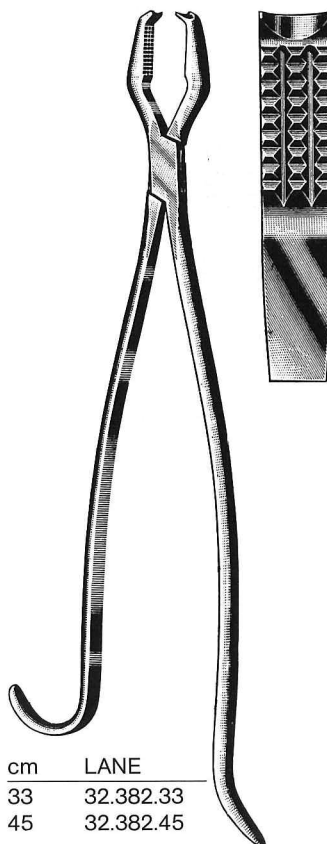

cm	LANE
33	32.382.33
45	32.382.45

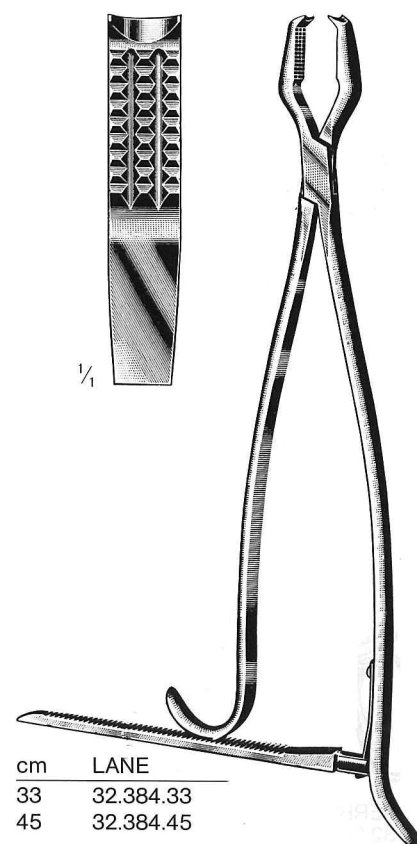

cm	LANE
33	32.384.33
45	32.384.45



**Knochenhaltezangen**

Bone Holding Forceps  
 Daviers porte os  
 Pinzas para huesos  
 Tenaglie per ossa



32.391.15-32.391.28

Selbstzentrierend  
 self-centering  
 autocentrant  
 autocentrantes  
 autocentranti



32.391.15  
 15 cm

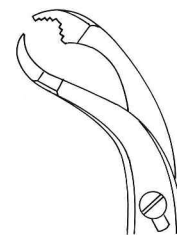

32.391.19  
 19 cm

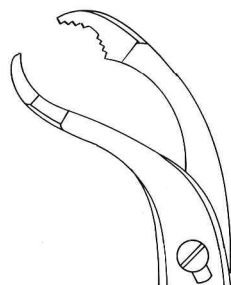

32.391.24  
 24 cm

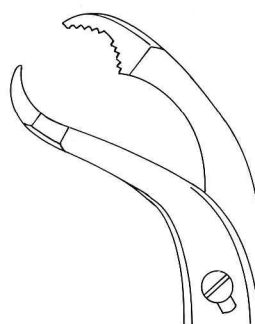

32.391.26  
 26 cm

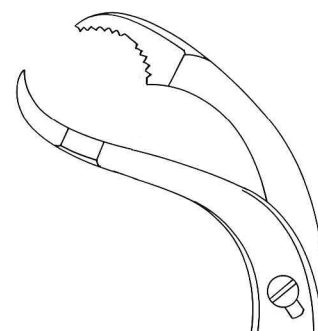

32.391.28  
 28 cm

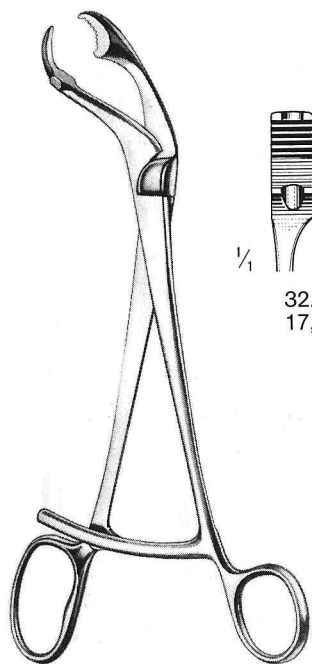

VERBRUGGE  
 32.395.17-32.395.27

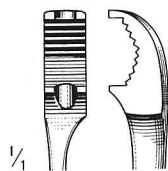

32.395.17  
 17,5 cm

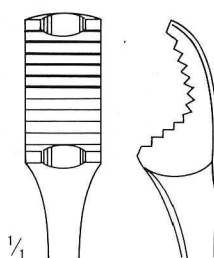

32.395.25  
 25 cm

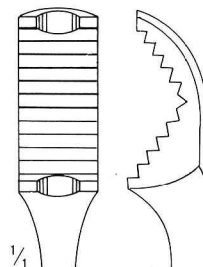

32.395.26  
 26 cm

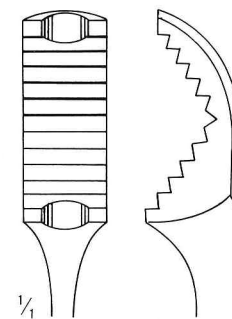

32.395.27  
 27 cm

## Knochenhalte-, Sequesterzangen

Bone Holding, Sequester Forceps

Pinces à os, à séquestres

Pinzas para huesos y secuestros

Pinze per ossa e sequestri

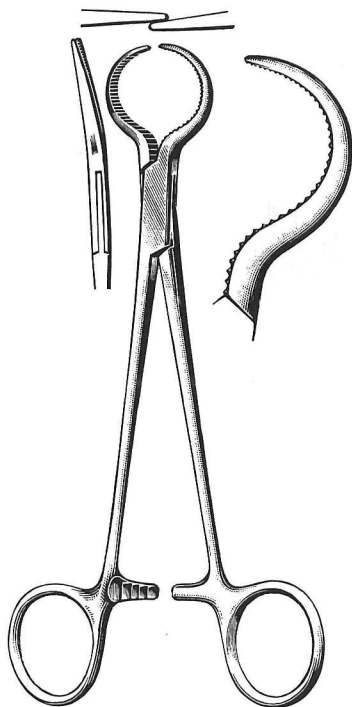

LEWIN  
32.402.17  
17,5 cm

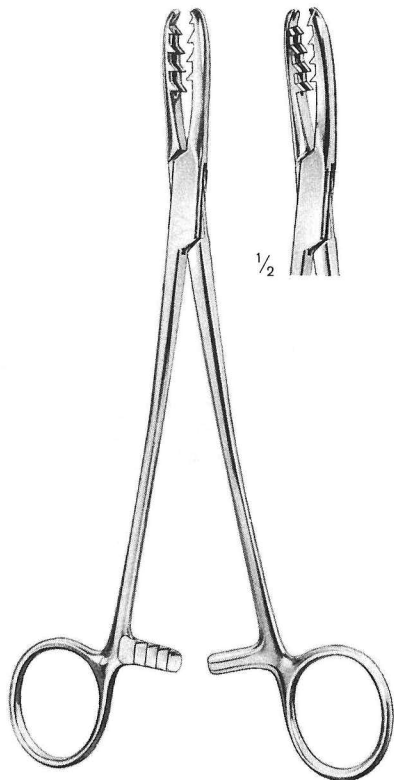

— BIRCHER-GANSKE —  
32.404.20 20 cm 32.405.20

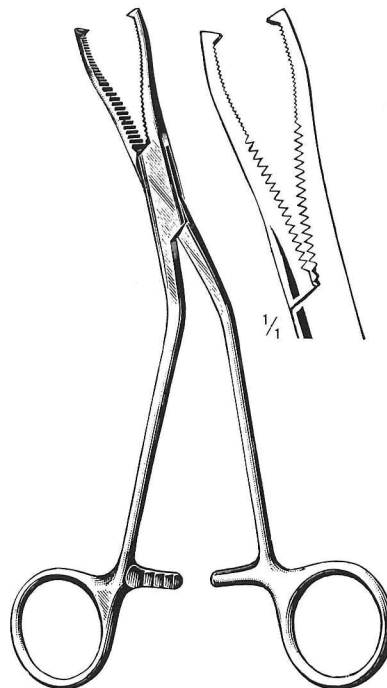

DINGMANN  
32.407.19  
19 cm



32.409.13  
13,5 cm

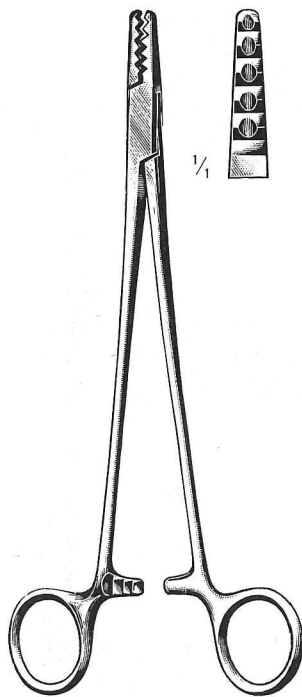

MARTIN  
32.410.19  
19 cm

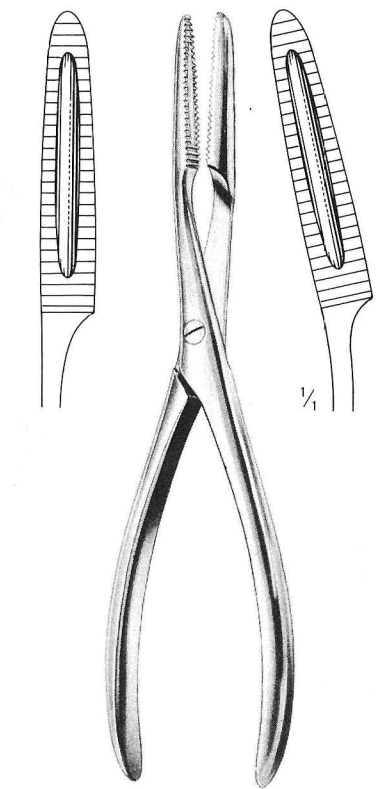

— 32.420.20 20 cm 32.421.20 —

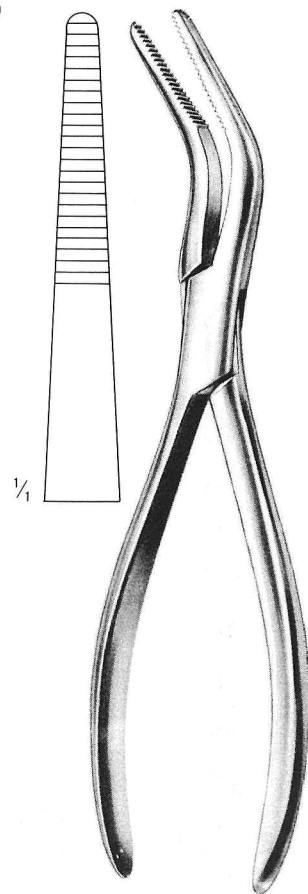

VAN BUREN  
32.423.23  
23 cm

**Knochenchirurgie**

Bone Surgery  
Chirurgie osseuse  
Cirugía ósea  
Chirurgia ossa

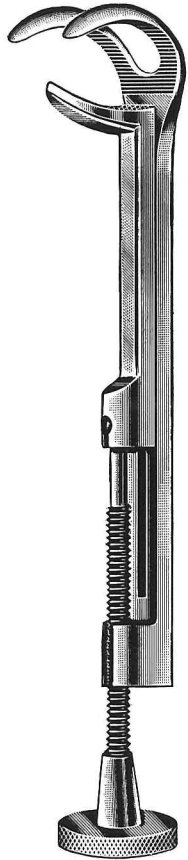

cm	LOWMAN
13	32.441.13
18,5	32.441.18
20	32.441.20

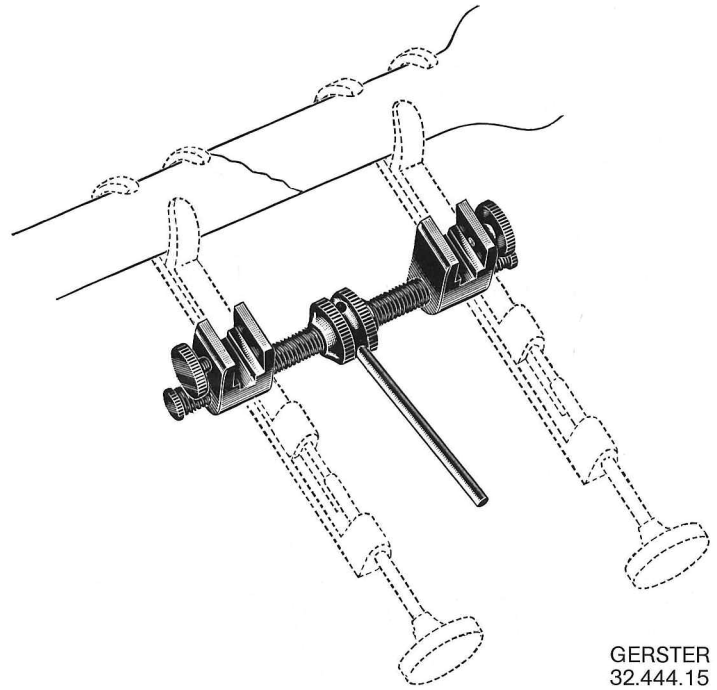

GERSTER  
32.444.15



cm	PARHAM
18	32.448.18
30	32.448.30

PARHAM  
32.446.24

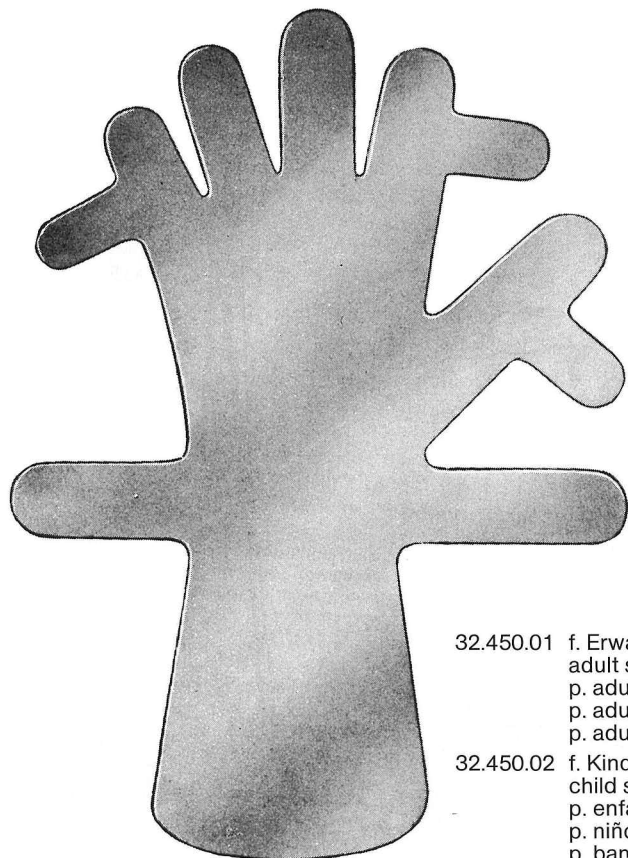

32.450.01 f. Erwachsene  
adult size  
p. adultes  
p. adultos  
p. adulti

32.450.02 f. Kinder  
child size  
p. enfants  
p. niños  
p. bambini

## Scharfe Löffel

Bone Currettes  
Curettes à os  
Cucharillas cortantes  
Curette taglianti

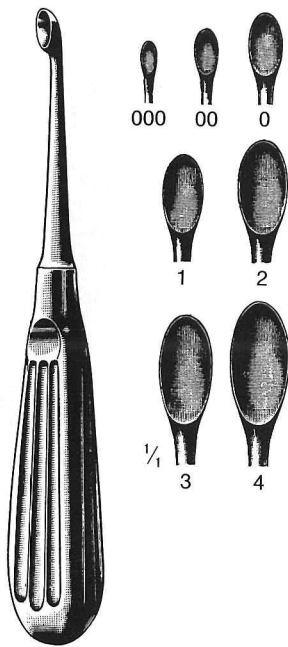

SCHEDE  
32.467.97-32.468.04

SCHEDE	Fig.	VOLKMANN
	0000	32.469.96
32.467.97	000	32.469.97
32.467.98	00	32.469.98
32.468.00	0	32.470.00
32.468.01	1	32.470.01
32.468.02	2	32.470.02
32.468.03	3	32.470.03
32.468.04	4	32.470.04
	5	32.470.05
	6	32.470.06

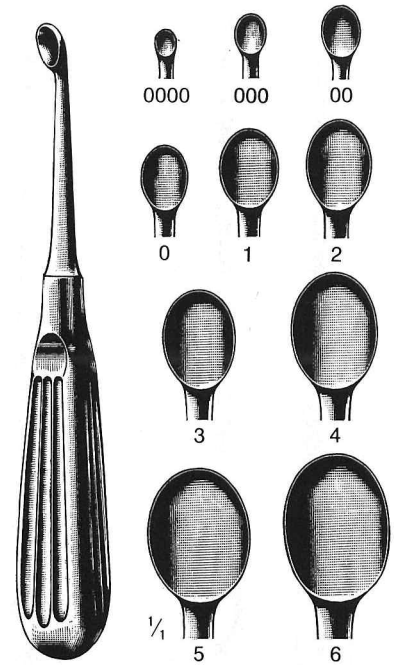

VOLKMANN  
32.469.96-32.470.06

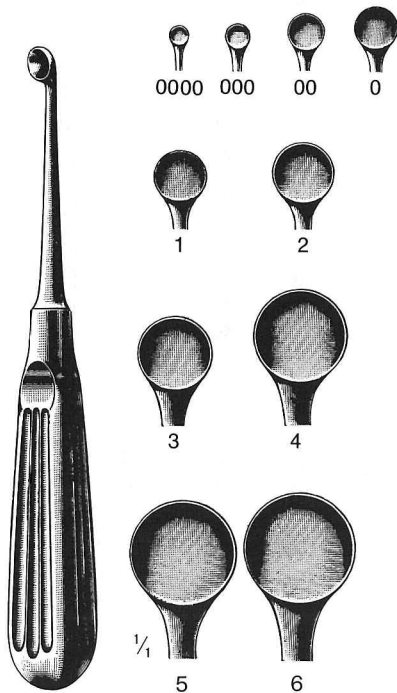

BRUNS  
32.471.96-32.472.06

BRUNS	Fig.	SPRATT
32.471.96	0000	32.474.96
32.471.97	000	32.474.97
32.471.98	00	32.474.98
32.472.00	0	32.475.00
32.472.01	1	32.475.01
32.472.02	2	32.475.02
32.472.03	3	32.475.03
32.472.04	4	32.475.04
32.472.05	5	32.475.05
32.472.06	6	

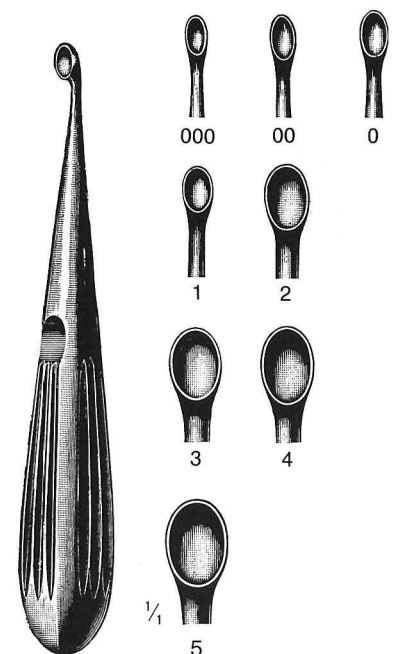

SPRATT  
32.474.97-32.475.05

**Scharfe Löffel**

Bone Curettes  
Curettes à os  
Cucharillas cortantes  
Curette taglianti

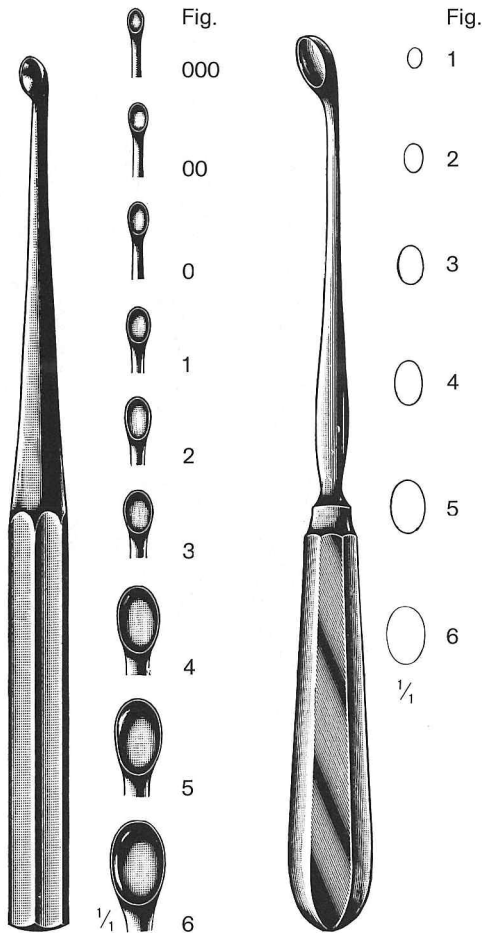

BRUNS 23 cm		SIMON 24 cm	
Fig.			
000	32.480.97		
00	32.480.98		
0	32.481.00		
1	32.481.01	32.485.01	
2	32.481.02	32.485.02	
3	32.481.03	32.485.03	
4	32.481.04	32.485.04	
5	32.481.05	32.485.05	
6	32.481.06	32.485.06	

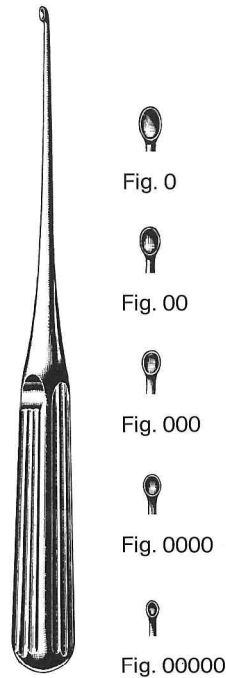

LEMPERT 21,5 cm	
Fig.	
0	32.490.10
00	32.490.20
000	32.490.30
0000	32.490.40
00000	32.490.50

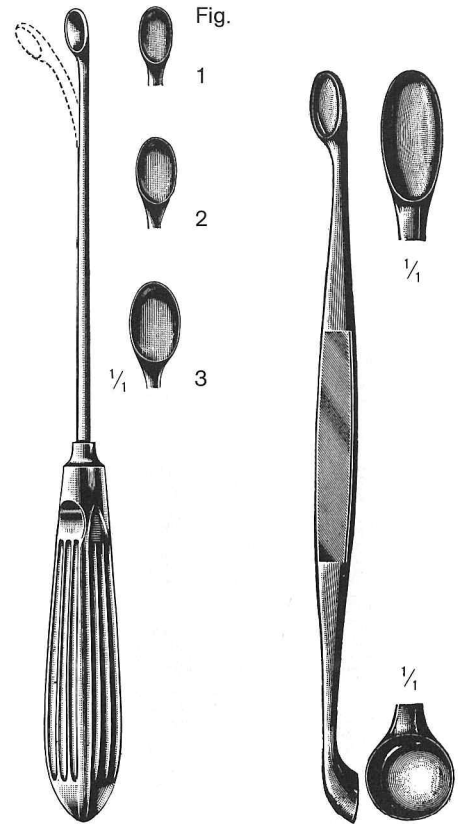

HALLE 21 cm		VOLKMANN	
Fig.		cm	
1	32.491.01	13	32.492.13
2	32.491.02	16	32.492.16
3	32.491.03	20	32.492.20

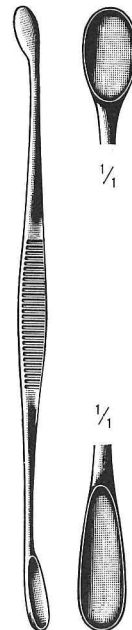

VOLKMANN	
cm	
13	32.494.13
14	32.494.14
17	32.494.17

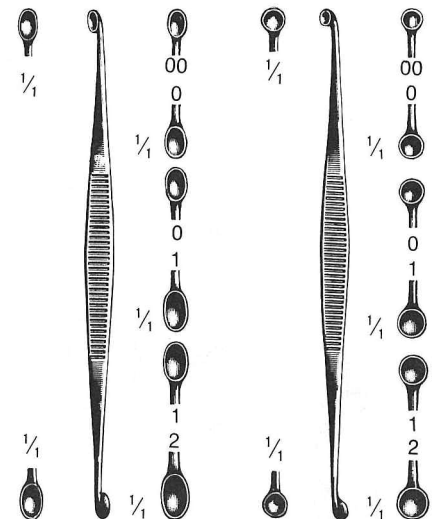

WILLIGER 13,5 cm		MARTINI 13,5 cm	
Fig.			
00/0	32.496.00	00	32.498.00
0/1	32.496.01	0	32.498.01
1/2	32.496.12	1	32.498.12

## Knochenmeißel

Bone Chisels and Gouges

Ciseaux-burins, gouges

Cinceles, gubias

Scalpelli, sgorbie

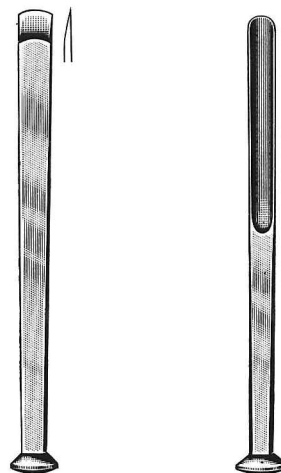
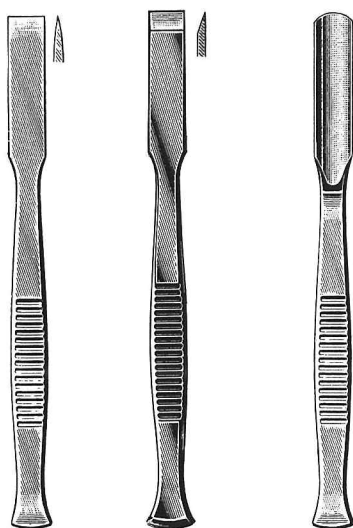

mm	13,5 cm	13,5 cm	13,5 cm	ALEXANDER 17 cm	ALEXANDER 17 cm
4	32.602.04	32.604.04	32.605.04	32.610.04	32.611.04
6		32.604.06		32.610.06	32.611.06
8	32.602.08	32.604.08	32.605.08	32.610.08	32.611.08
10	32.602.10	32.604.10	32.605.10	32.610.10	32.611.10
12	32.602.12	32.604.12	32.605.12	32.610.12	32.611.12
14	32.602.14	32.604.14	32.605.14	32.610.14	32.611.14
16	32.602.16	32.604.16	32.605.16		

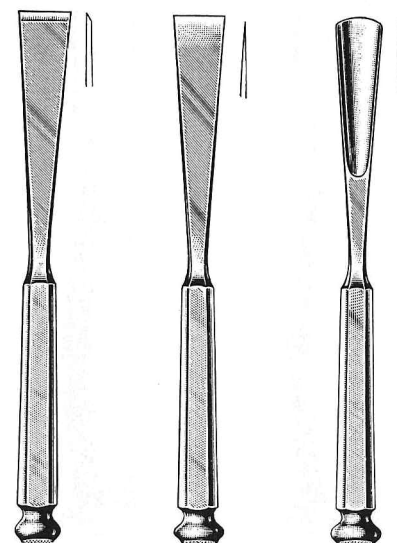
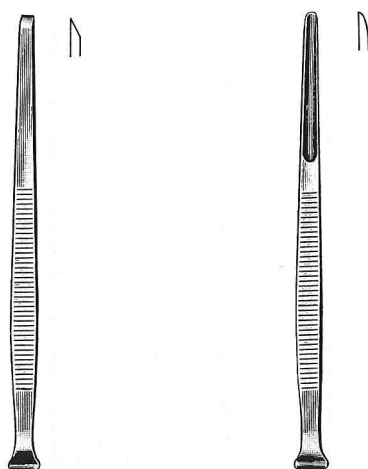

mm	PARTSCH		PARTSCH	
	13,5 cm	17 cm	13,5 cm	17 cm
2	32.620.02	32.622.02	32.623.02	32.625.02
3	32.620.03	32.622.03	32.623.03	32.625.03
4	32.620.04	32.622.04	32.623.04	32.625.04
5	32.620.05	32.622.05	32.623.05	32.625.05
6	32.620.06	32.622.06	32.623.06	32.625.06
7	32.620.07	32.622.07	32.623.07	32.625.07
8	32.620.08	32.622.08	32.623.08	32.625.08

mm	STILLE		
	20 cm	20 cm	20 cm
10	32.630.10	32.632.10	32.633.10
15	32.630.15	32.632.15	32.633.15
20	32.630.20	32.632.20	32.633.20
25	32.630.25	32.632.25	32.633.25

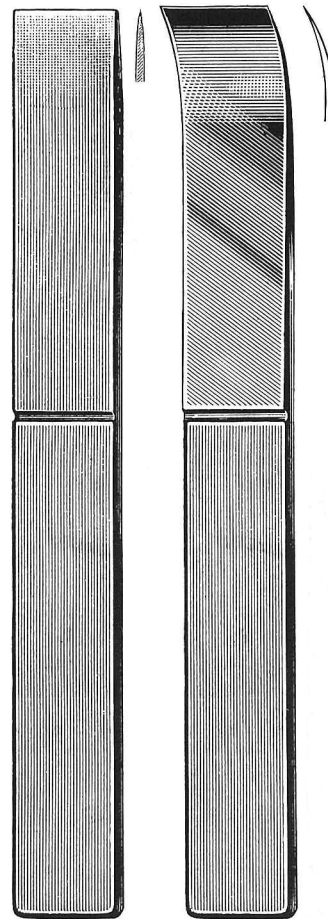
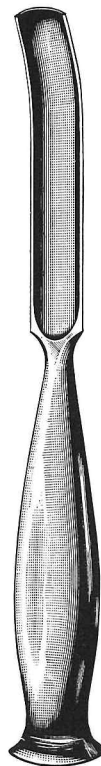
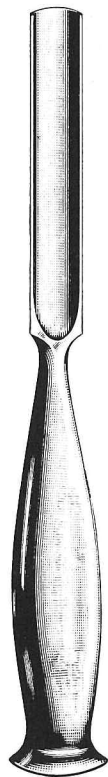

mm	SMITH-PETERSEN			
6	32.634.06	32.635.06	32.637.06	32.639.06
9	32.634.09	32.635.09	32.637.09	32.639.09
13	32.634.13	32.635.13	32.637.13	32.639.13
16	32.634.16	32.635.16	32.637.16	32.639.16
19	32.634.19	32.635.19	32.637.19	32.639.19
25	32.634.25	32.635.25	32.637.25	32.639.25
32	32.634.32	32.635.32	32.637.32	32.639.32
	20 cm	20 cm	20 cm	20 cm

mm	LAMBOTTE		LAMBOTTE mini	
6,5	32.650.06	32.651.06	3	32.654.03
15,0	32.650.15	32.651.15	4	32.654.04
20,0	32.650.20	32.651.20	6	32.654.06
25,0	32.650.25	32.651.25	8	32.654.08
30,0	32.650.30	32.651.30	10	32.654.10
38,0	32.650.38	32.651.38	12	32.654.12
44,0	32.650.44	32.651.44	15	32.654.15
	24 cm	23 cm		12,5 cm

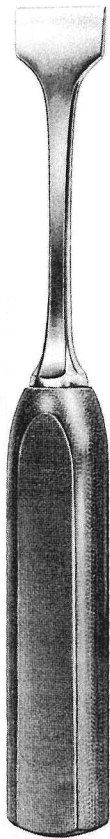

mm	LEXER	LEXER
7	32.660.07	32.661.07
10	32.660.10	32.661.10
15	32.660.15	32.661.15
20	32.660.20	32.661.20
25	32.660.25	32.661.25
30	32.660.30	32.661.30
	22 cm	22 cm

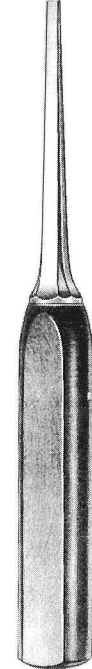
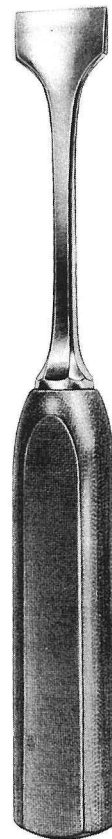

mm	LEXER mini	LEXER mini
4	32.664.04	32.665.04
6	32.664.06	32.665.06
8	32.664.08	32.665.08
10	32.664.10	32.665.10
12	32.664.12	32.665.12



mm	HOKE
3	32.668.03
5	32.668.05
6	32.668.06
8	32.668.08
9	32.668.09
	17 cm

mm		
6	32.670.06	32.672.06
13	32.670.13	32.672.13
19	32.670.19	32.672.19
25	32.670.25	32.672.25
32	32.670.32	32.672.32
	24 cm	24 cm

HIBBS		
32.671.06	32.673.06	32.675.06
32.671.13	32.673.13	32.675.13
32.671.19	32.673.19	32.675.19
32.671.25	32.673.25	32.675.25
32.671.32	32.673.32	32.675.32
24 cm	24 cm	24 cm



**Knochenmeißel**  
 Bone Chisels and Gouges  
 Ciseaux-burins, gouges  
 Cinceles, gubias  
 Scalpelli, sgorbie

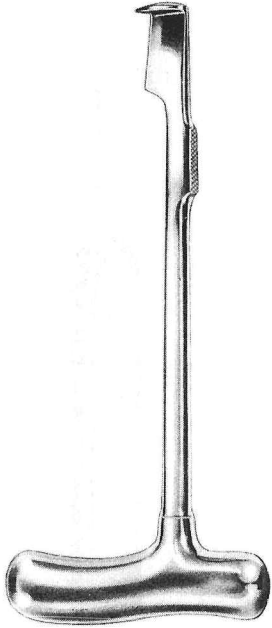

LEBSCHE  
 32.678.24  
 24,5 cm

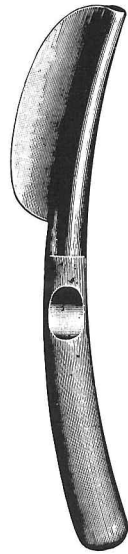

32.679.22  
 22 cm

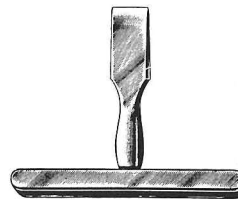

VIRCHOW  
 32.680.12



BRUNETTI  
 32.681.28  
 28 cm



BRUNETTI  
 32.683.28  
 28 cm

Autopsie-Besteck  
 Post Mortem Set  
 Set à autopsie  
 Juego de autopsia  
 Set per autopsia



32.684.00

## Hämmer

Bone Hammers and Mallets

Maillets

Martillos y mazos

Martelli

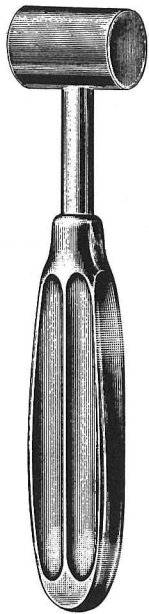

GERZOG  
32.686.25  
18 cm 250 g

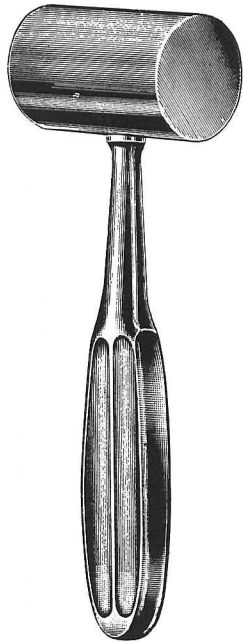

KIRK  
32.688.75  
19 cm 750 g

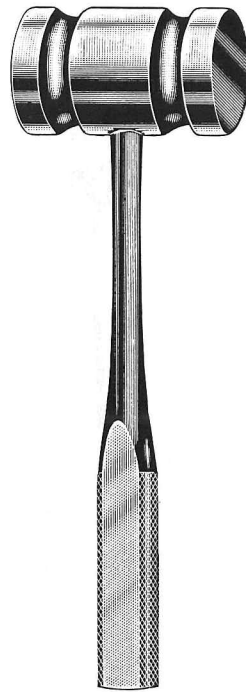

g	
450	32.690.45
900	32.690.90
26,5 cm	



COLLIN  
32.692.22  
20 cm 220 g

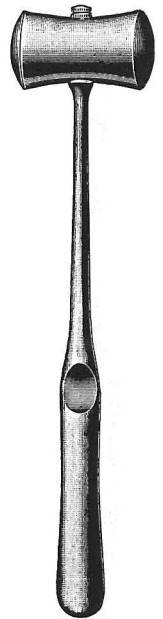

WILLIGER  
32.694.34  
24 cm 340 g

32.697.02  
Paar Ersatzbacken  
Pair of Spare Faces  
Paire de faces de rechange  
Pareja de tapas intercambiables  
Coppia di teste di ricambio

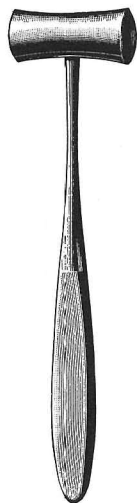

LUCAE  
32.696.26  
19 cm 260 g



MEAD  
32.696.32  
17 cm 320 g

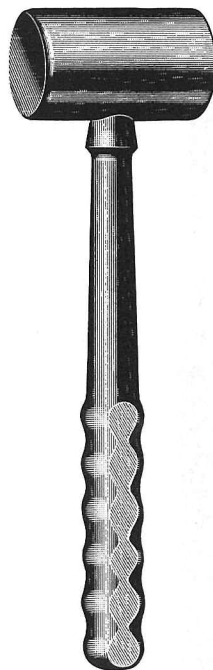

g	
250	32.698.25
400	32.698.40
26 cm	

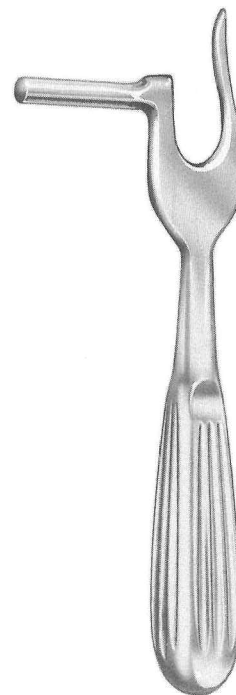

QUISLING  
32.698.75

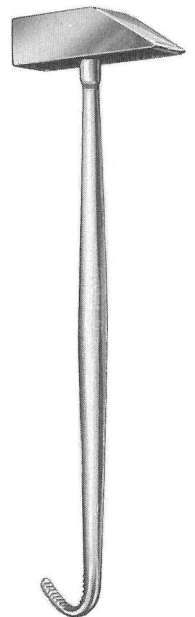

32.699.00  
23,5 cm

**Raspatorien**  
 Periosteal Elevators  
 Rugines-raspatoires  
 Periostótomos  
 Periostotomi

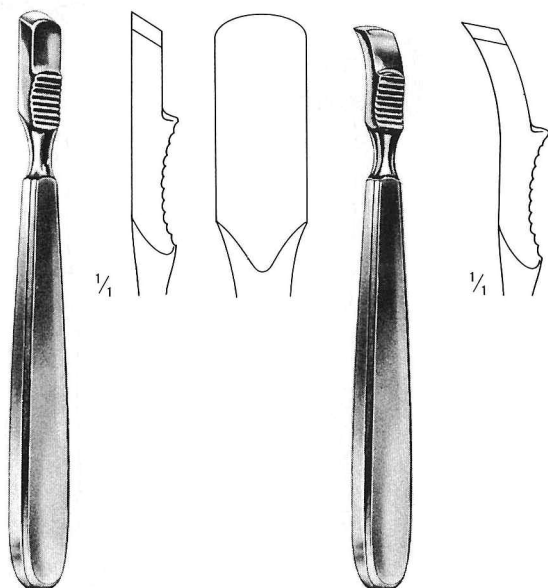

**FARABEU**  
 32.702.15  
 15 cm

**FARABEU**  
 32.703.15  
 15 cm

mm	LAMBOTTE
10	32.705.10
15	32.705.15
20	32.705.20
25	32.705.25
	21 cm

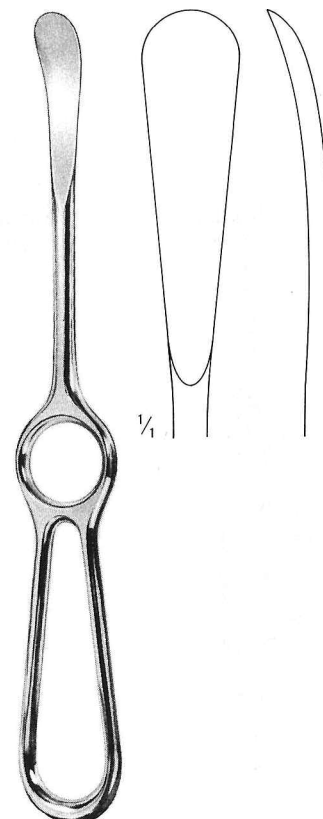
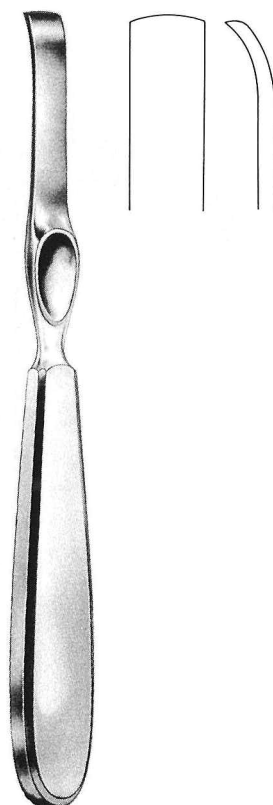

**SEDILLOT**  
 32.709.21  
 21 cm

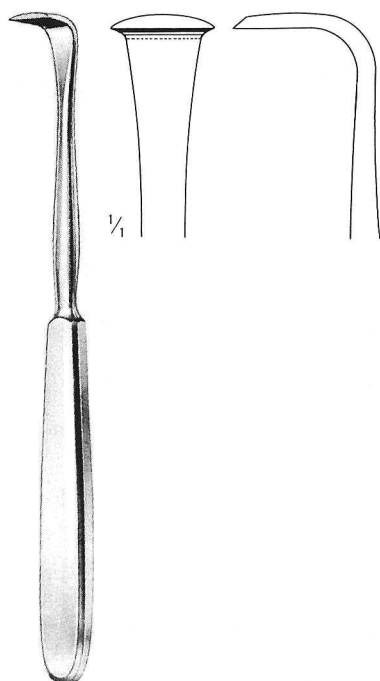

**LANGENBECK**  
 32.711.18  
 18 cm

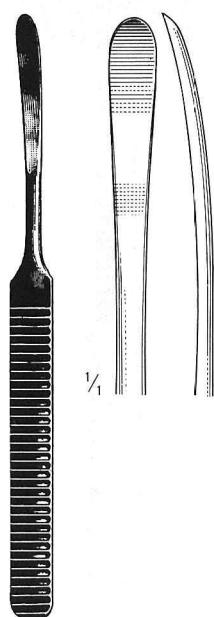

**WILLIGER**  
 32.713.16  
 16 cm

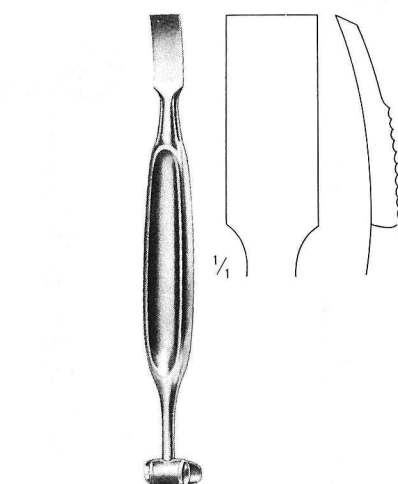

cm	ALEXANDER
16	32.715.16
20	32.715.20

**Raspatorien**  
 Periosteal Elevators  
 Rugines-raspatoires  
 Periostótomos  
 Periostotomi

Für Rippen  
 Rib  
 Pour les côtes  
 Para costillas  
 Costali

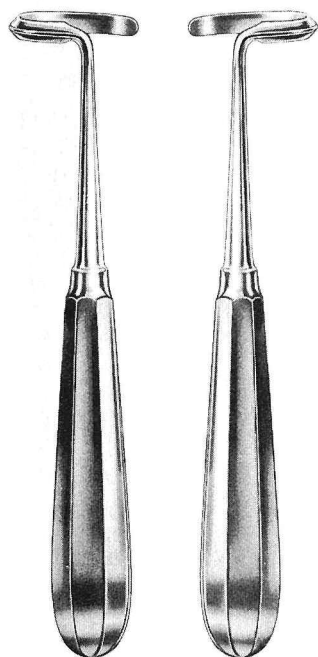

DOYEN DOYEN  
 32.721.17-32.727.17  
 17 cm

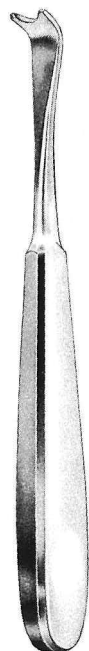
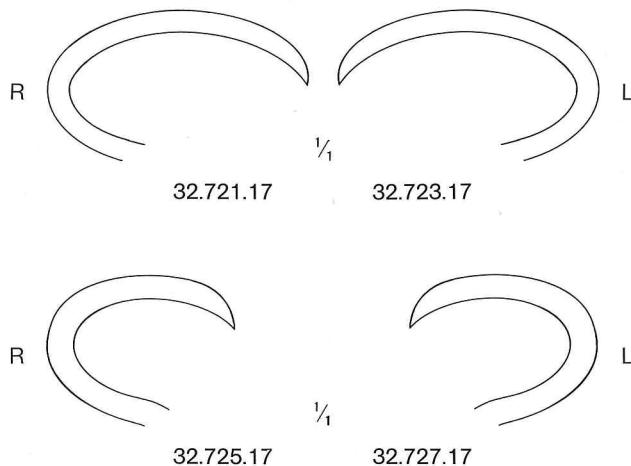

SEMB  
 32.729.01 -  
 32.729.07



32.729.01  
 17,5 cm



32.729.02  
 21,0 cm



32.729.03  
 17,5 cm



32.729.04  
 21,0 cm



32.729.05  
 20,5 cm

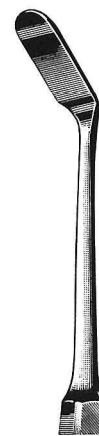

32.729.06  
 20,5 cm

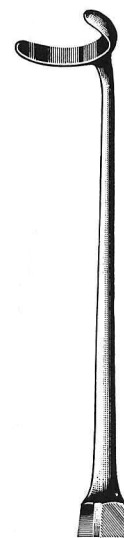

32.729.07  
 22,5 cm

**Elevatoren**

Elevators  
 Élévateurs  
 Elevadores  
 Elevatori

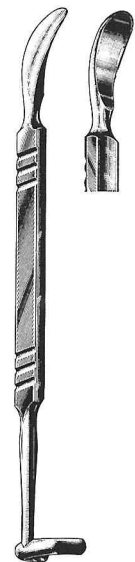

**MATSON**  
 32.733.22  
 22 cm

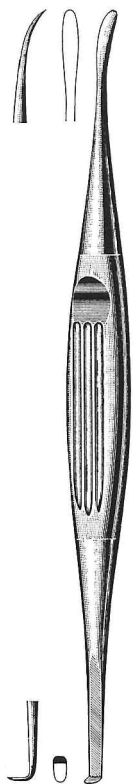

**OVERHOLT**  
 32.735.29  
 29,5 cm

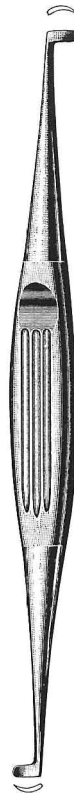

**OVERHOLT**  
 32.737.29  
 29,5 cm

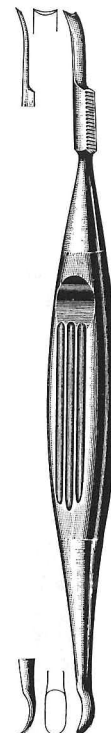

**OVERHOLT**  
 32.739.28  
 28,5 cm

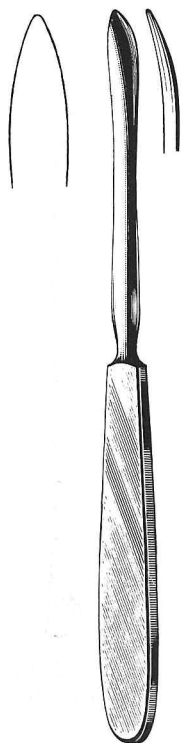

**LANGENBECK**  
 32.751.20  
 20 cm

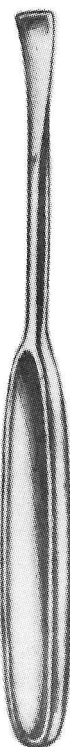

**LANGENBECK**  
 32.753.20  
 20 cm



**ADSON**  
 32.754.17 -  
 32.757.17  
 17 cm



32.754.17



32.755.17

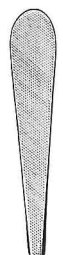

32.756.17



32.757.17



**KEY**  
 32.759.06 -  
 32.759.25  
 19 cm

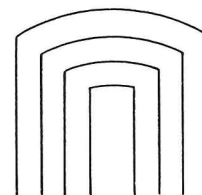

mm	
6	32.759.06
12	32.759.12
19	32.759.19
25	32.759.25

## Elevatoren, Knochenheber

Elevators, Bone Levers

Élévateurs, Leviers à os

Elevadores, E, para huesos

Elevatori, Elevatori per ossa

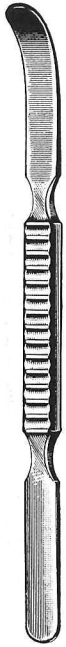

WATSON-CHEYNE  
32.765.17  
17,5 cm



McDONALD  
32.767.19  
19 cm



MURPHY-LANE  
32.769.30  
30 cm

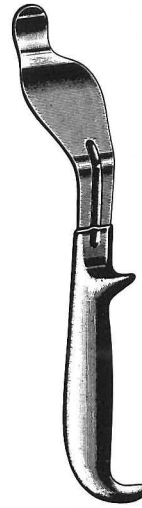

BENNETT  
32.771.71  
65x260 mm

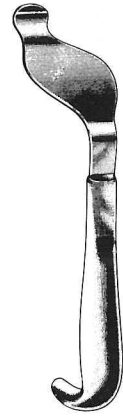

BENNETT  
32.771.73  
45x260 mm

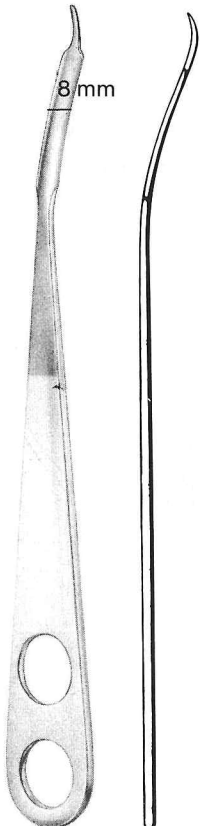

HOHMANN  
32.801.08  
8 mm

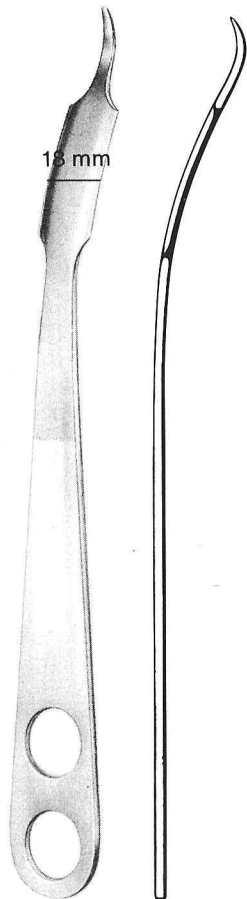

HOHMANN  
32.801.18  
18 mm

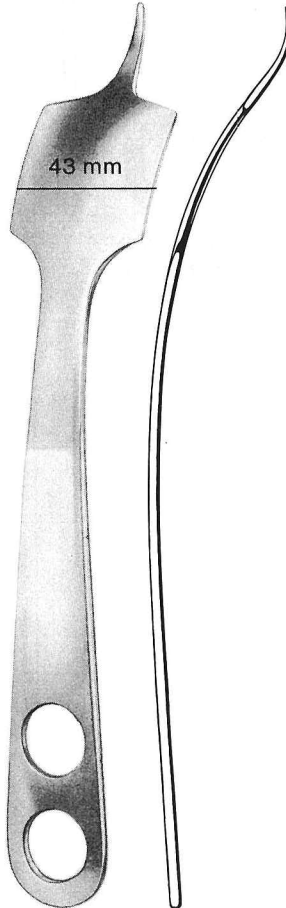

HOHMANN  
32.801.43  
43 mm



HOHMANN  
32.801.70  
70 mm

# Knochenheber

Bone Levers

Leviers à os

Elevadores para huesos

Elevatori per ossa



HOHMANN  
32.803.43  
43 mm

HOHMANN  
32.805.22  
22 mm

HOHMANN  
32.805.33  
33 mm

HOHMANN  
32.807.24  
24 mm

HOHMANN  
32.809.22  
22 mm

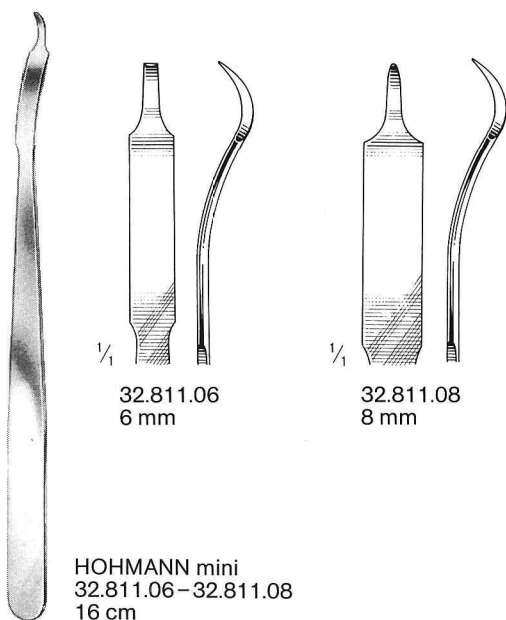

HOHMANN mini  
32.811.06-32.811.08  
16 cm

32.811.06  
6 mm

32.811.08  
8 mm

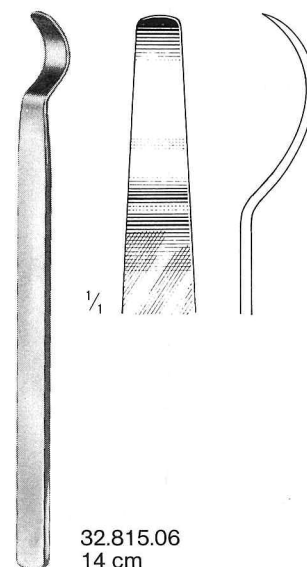

32.815.06  
14 cm

## Knochenchirurgie

Bone Surgery  
Chirurgie osseuse  
Cirugía ósea  
Chirurgia ossa

Knochenhebel  
Bone Levers  
Leviers à os  
Elevadores para huesos  
Elevatori per ossa



BLOUNT  
32.823.26  
26 cm

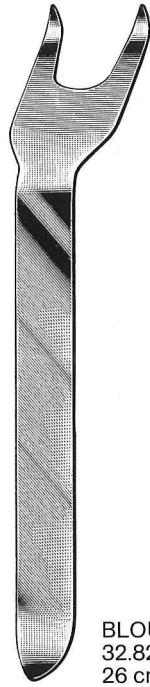

BLOUNT  
32.825.26  
26 cm

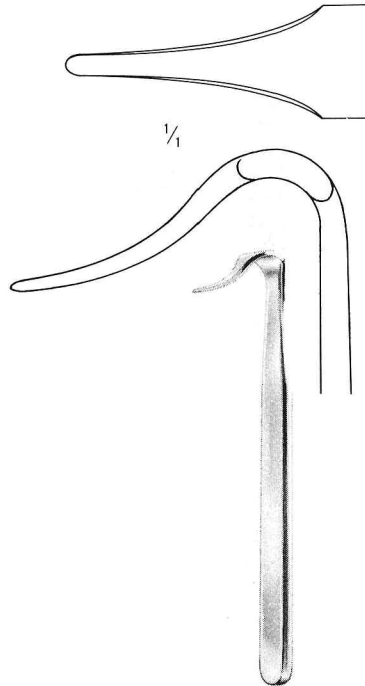

BLOUNT  
32.827.17  
17,5 cm

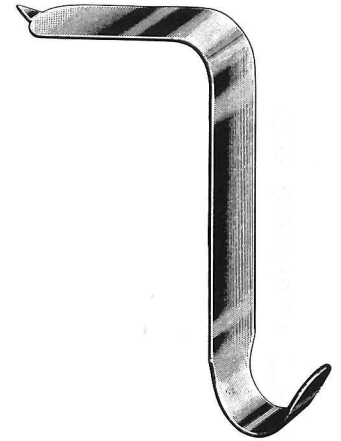

mm x mm	TAYLOR
75x30	32.831.16
100x30	32.833.16
16,5 cm	

Meniskotome · Meniscotomes  
Meniscotomes · Meniscótomos  
Meniscotomi

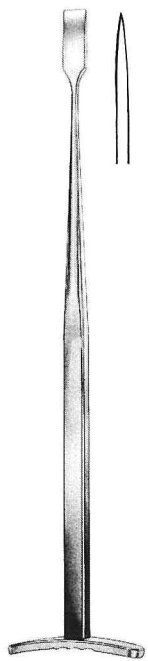

SMILLIE  
32.910.17  
17 cm

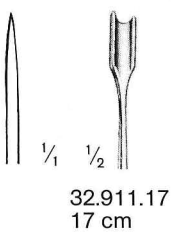

32.911.17  
17 cm

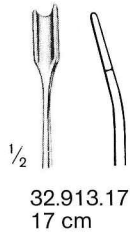

32.913.17  
17 cm

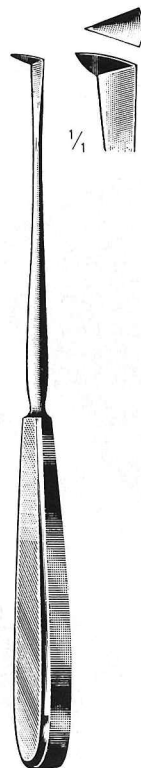

BIRCHER  
32.915.19  
19 cm

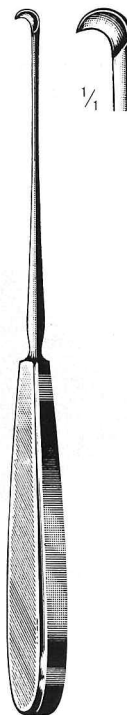

BIRCHER  
32.917.19  
19 cm

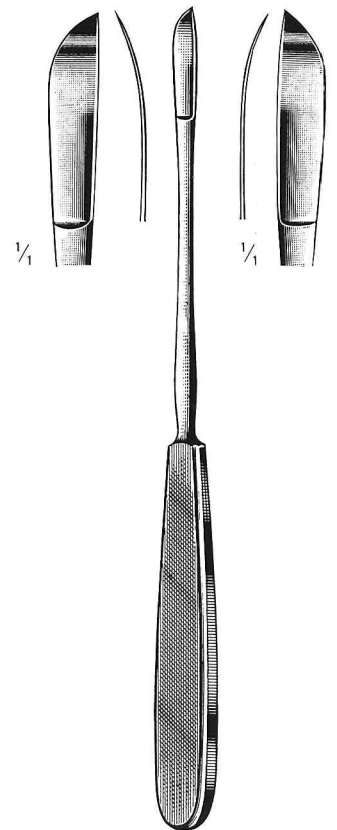

NEFF	
32.921.22	22 cm
32.923.22	



## Knochenchirurgie

Bone Surgery  
Chirurgie osseuse  
Cirugía ósea  
Chirurgia ossa

**dimeda**<sup>®</sup>  
SURGICAL INSTRUMENTS

Sehnenstripper, Knochenfeilen  
Tendon Strippers, Bone Files  
Instruments à écorcher les tendons, limes à os  
Separadores para tendones, limas para huesos  
Scollatendini, lime per ossa

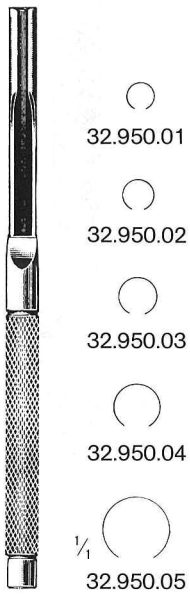

BUNNELL  
32.950.01 - 32.950.05  
15 cm



32.971.24  
24,5 cm

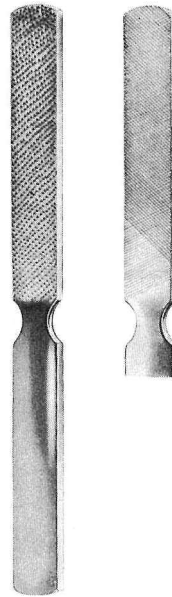

32.972.22  
22 cm



PUTTI  
32.973.27  
27 cm



PUTTI  
32.975.30  
30 cm

## Komprimeter

Comprimeter

Comprimètre

Torniquete

Apparechio per vuoto di sangue

Komprimeter zur Erzeugung von Blutleere in den Gliedern  
Compression Apparatus for producing blood vacuum in limbs  
Appareil compressif permettant d'obtenir un milieu exsangue des membres  
Aparato de compresión para producir el vacío de sangre en los miembros  
Vacometro per determinare vuoti di sangue nelle membra



33.101.01  
compl.

**Amputation, Finger**

Amputation, Fingers  
Amputation, doigts  
Amputación, dedos  
Amputazione, dita

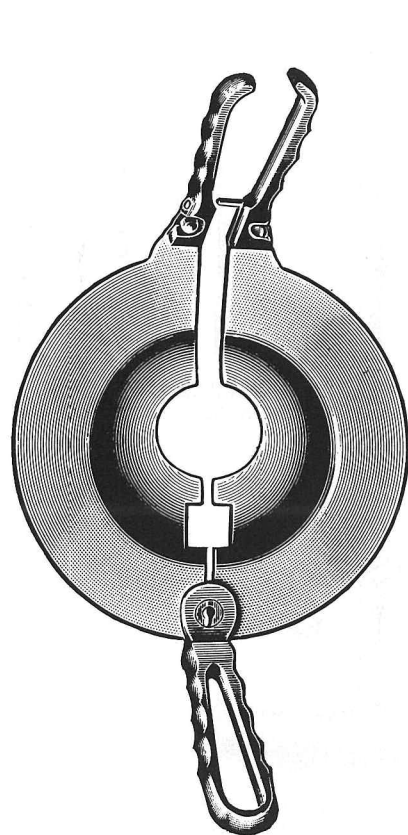

PERCY  
33.110.00

mm	
12	33.112.12
15	33.112.15
18	33.112.18

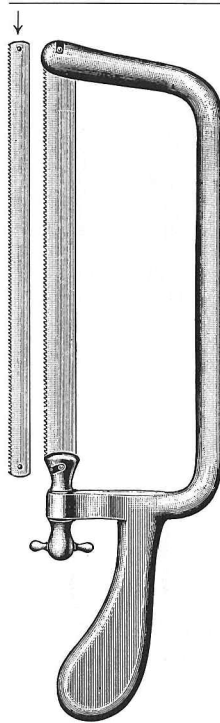

CHARRIERE  
33.112.00

33.116.99

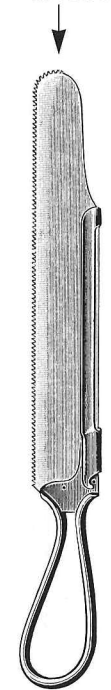

CHARRIERE  
33.116.30  
30 cm

33.118.99

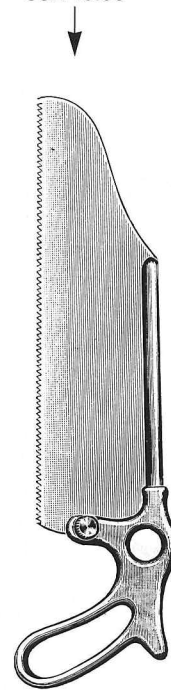

SATTERLEE  
33.118.31  
31 cm



LANGENBECK  
33.120.23  
23 cm

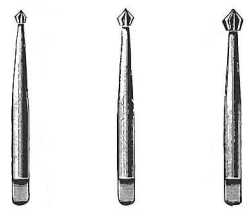

33.160.01

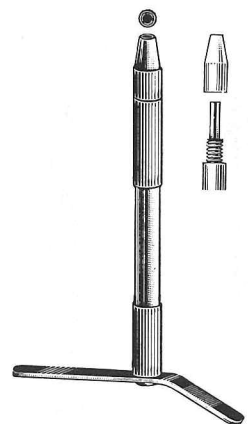

33.160.00  
Compl. incl.  
33.160.01

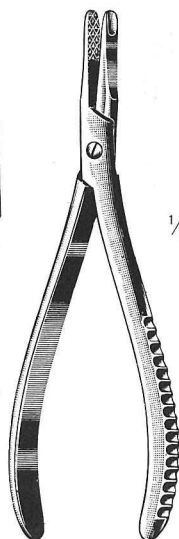
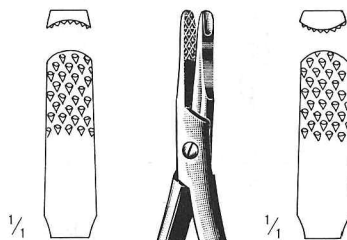

RADOLF  
33.162.13  
13,5 cm

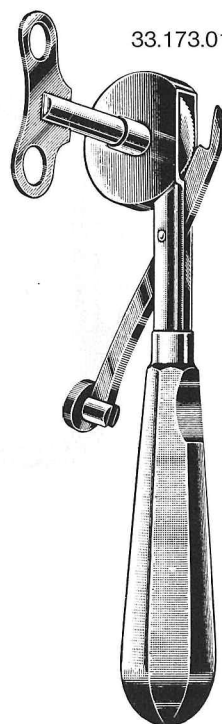

33.173.01

DIMEDA  
33.173.00  
17 cm



33.175.01

33.175.00

## Handbohrapparate

Bone Hand Drills  
Perforateurs à main  
Perforadores a mano  
Perforatori a mano

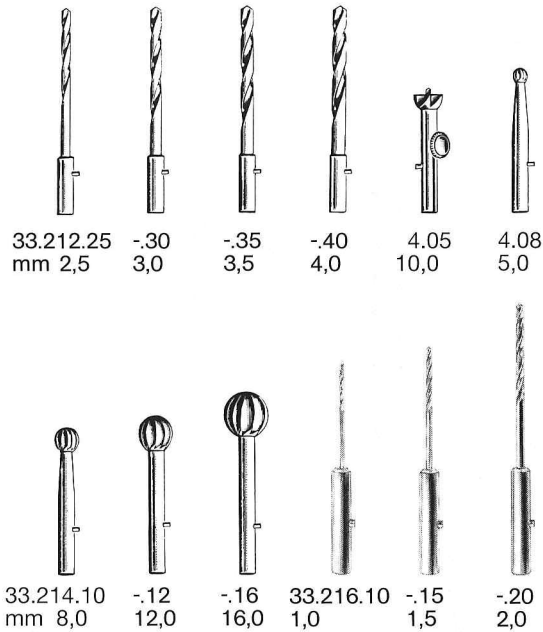
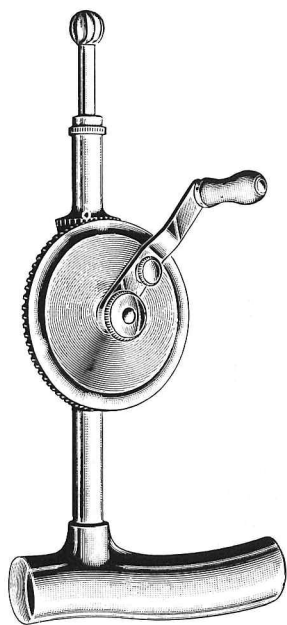

33.212.25 -30  
mm 2,5 3,0

-35 3,5

-40 4,0

4.05 10,0

4.08 5,0

33.214.10 -12  
mm 8,0 12,0

-16 16,0

33.216.10 -15  
1,0 1,5

-20 2,0

STILLE

33.210.20  
Compl. 20 cm

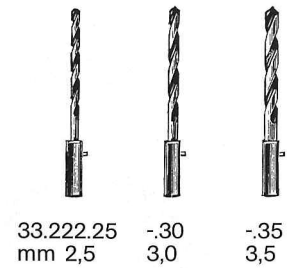
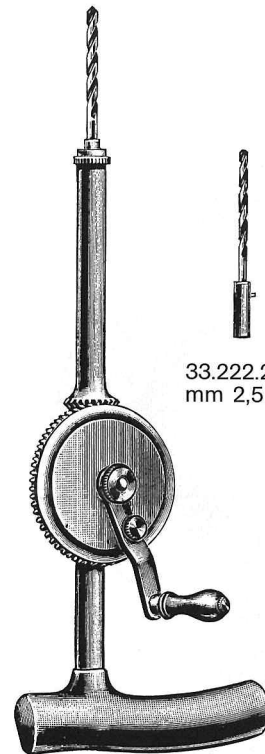

33.222.25 -30  
mm 2,5 3,0

-35 3,5

STILLE-SHERMAN

33.220.24  
Compl. 24 cm

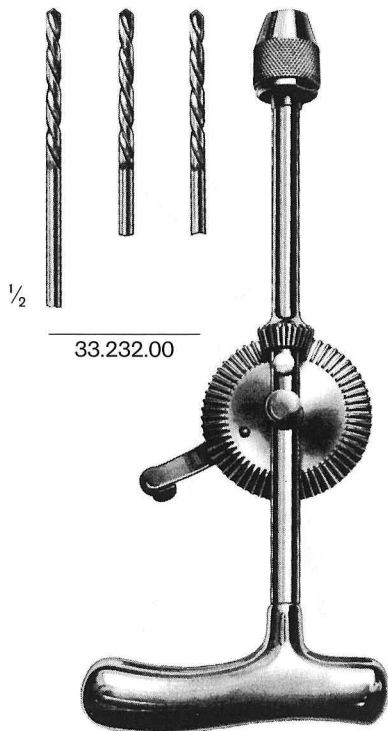

1/2

33.232.00

MOORE  
33.230.28  
Compl. 28 cm

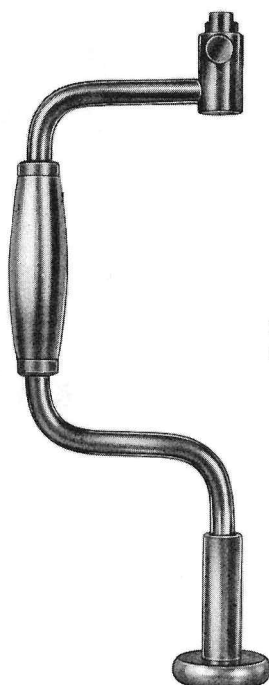

1/3  
33.242.09  
mm 9

1/3  
33.242.14  
14

1/3  
33.242.16  
16

1/3  
33.242.22  
22

1/3  
CUSHING  
33.244.14

33.246.00

McKENZIE  
33.248.00

HUDSON  
33.240.27  
Compl. incl. 33.242.09, -14, -16, -22, 33.246.00  
27 cm

## Handbohrapparate

Bone Hand Drills  
Perforateurs à main  
Perforadores a mano  
Perforatori a mano

**dimeda**<sup>®</sup>  
SURGICAL INSTRUMENTS

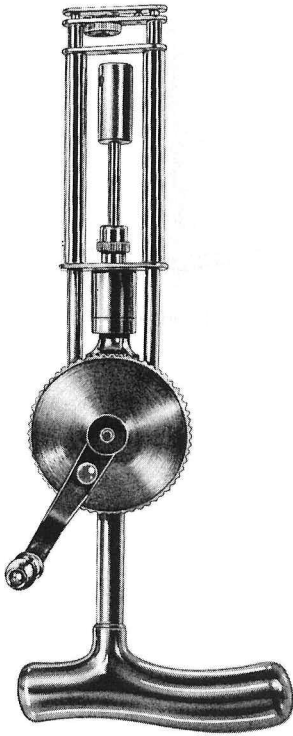

KIRSCHNER  
33.250.00  
Compl.

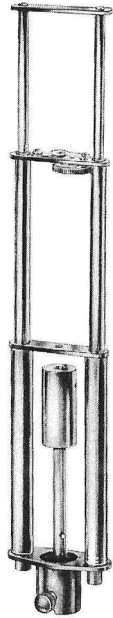

33.252.00

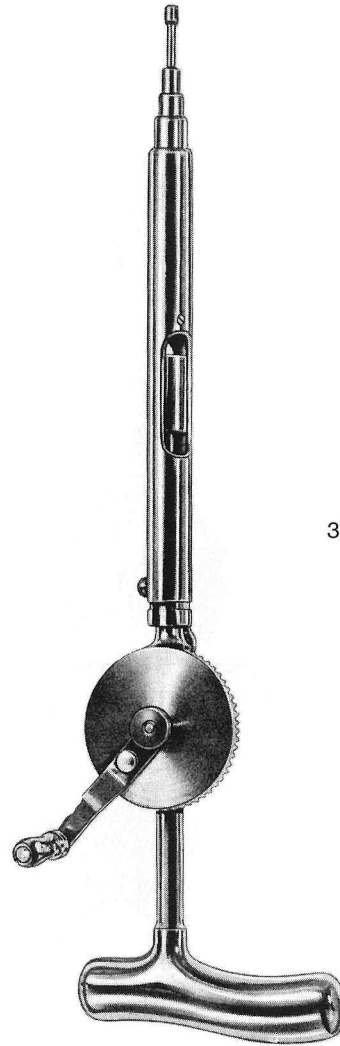

33.260.00  
Compl.



33.262.00

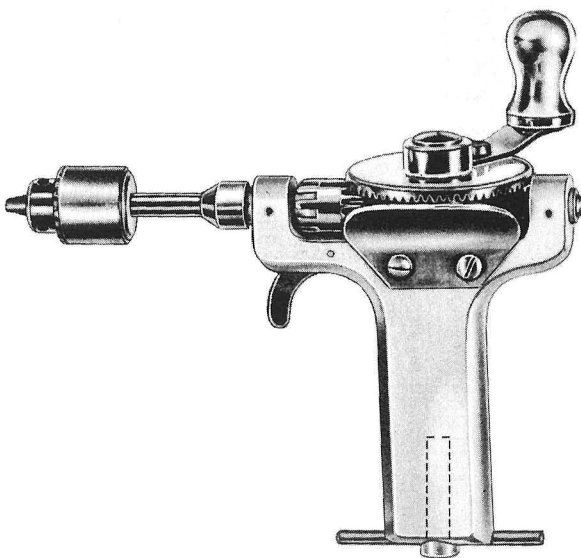

BUNNELL  
33.270.00  
16 cm

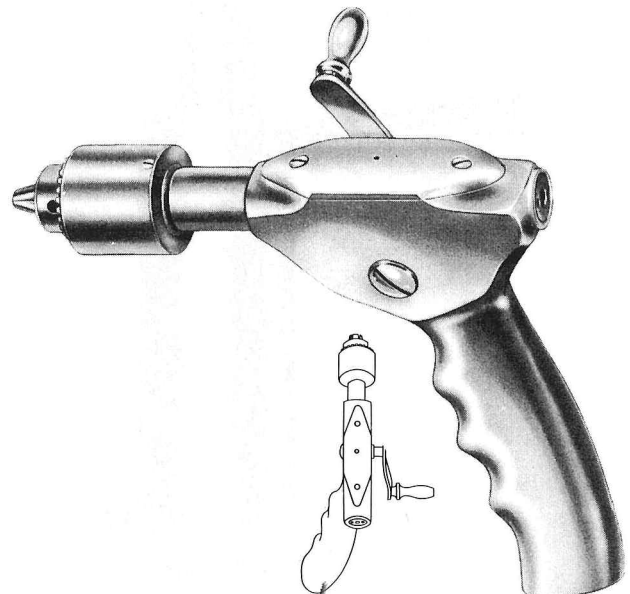

RALK  
33.280.00

Orthopédie, Osteosynthese / Bone Surgery, Osteosynthesis / Chirurgie osseuse, Ostéosynthèse / Chirurgia ósea, Osteosíntesi

## Bohrapparate

Bone Drills

Perforateurs à os

Perforadores para huesos

Perforatori per ossa

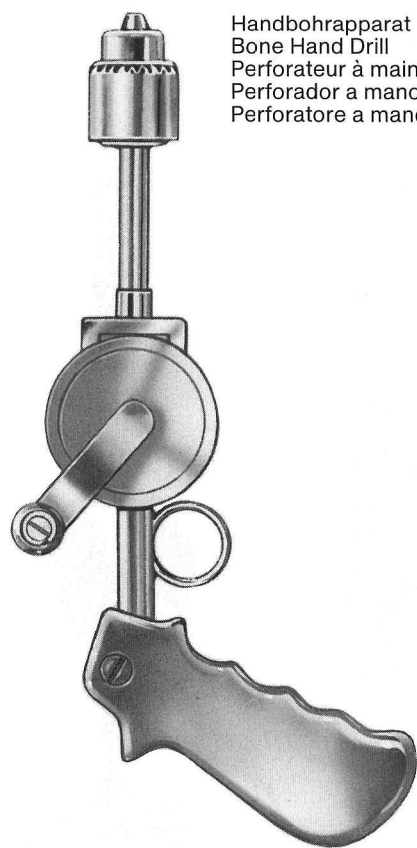

Handbohrapparat  
Bone Hand Drill  
Perforateur à main  
Perforador a mano  
Perforatore a mano

33.290.00

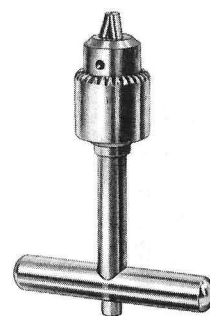

33.296.00

## Bohrer, Fräser, Trephinen

Burrs, Drills, Trephines  
Mèches, fraises, trépan  
Taladros, fresas, trefinas  
Trapani, frese, trefine

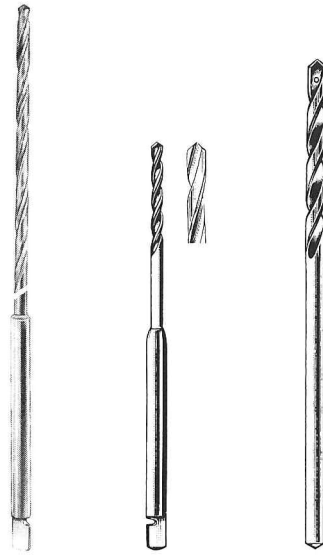

mm			
1,0		33.352.10	33.354.10
1,2		33.352.12	
1,5		33.352.15	33.354.15
1,8		33.352.18	
2,0	33.350.20	33.352.20	33.354.20
2,2		33.352.22	
2,5	33.350.25	33.352.25	33.354.25
2,8		33.352.28	33.354.28
3,0	33.350.30	33.352.30	33.354.30
3,2	33.350.32	33.352.32	33.354.32
3,5	33.350.35	33.352.35	33.354.35
4,0	33.350.40	33.352.40	33.354.40
5,0	33.350.50	33.352.50	33.354.50
6,0	33.350.60		33.354.60
7,0	33.350.70		



mm Ø	DOYEN	DOYEN	DOYEN	DOYEN	ALBEE	ALBEE	BORCHARDT	TOTI
4	33.362.04	33.364.04						
6	33.362.06	33.364.06						
7						33.374.07		
8	33.362.08	33.364.08		33.368.08	33.372.08			33.378.08
10	33.362.10	33.364.10		33.368.10	33.372.10			
12	33.362.12	33.364.12	33.366.12		33.370.12	33.372.12		
13							33.376.13	
14	33.362.14	33.364.14						
15					33.370.15			
16	33.362.16	33.364.16						
25								33.377.25

## Bohrinstrumente, Pfrieme

Boring Instruments, Awls

Instrumentos á percer, poincons

Instrumental para perforar, Escariadores

Strumenti per perforazione, Lesine

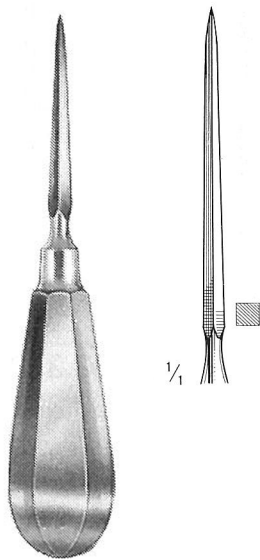

33.392.14  
14 cm

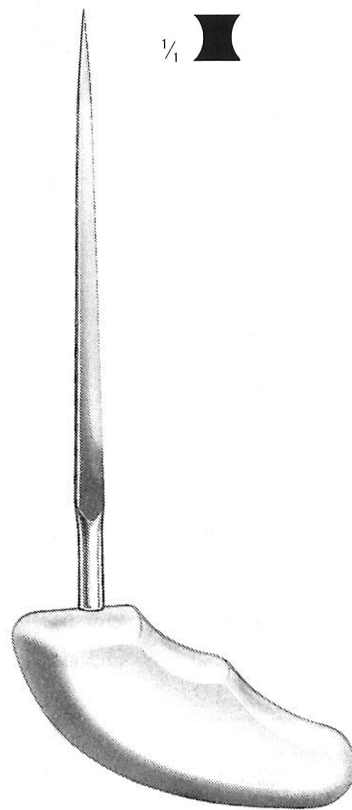

PERTHES  
33.395.21  
21 cm



**Bohrdrähte**

Wire Drills

Broches de KIRSCHNER

Taladros filiformes

Fili KIRSCHNER



Trokarspitze  
 Trocar tip  
 Pointe trocart  
 Punta en forma de trócar  
 Punte a trequarti

mm Ø	L = 60 mm	L = 120 mm	L = 140 mm	L = 160 mm	L = 310 mm
1,0	33.406.10	33.412.10	33.414.10	33.416.10	33.431.10
1,2	33.406.12	33.412.12	33.414.12	33.416.12	33.431.12
1,4	33.406.14	33.412.14	33.414.14	33.416.14	33.431.14
1,5	33.406.15	33.412.15	33.414.15	33.416.15	33.431.15
1,6	33.406.16	33.412.16	33.414.16	33.416.16	33.431.16
1,8	33.406.18	33.412.18	33.414.18	33.416.18	33.431.18
2,0	33.406.20	33.412.20	33.414.20	33.416.20	33.431.20
2,2	33.406.22	33.412.22	33.414.22	33.416.22	33.431.22
2,5				33.416.25	33.431.25

KIRSCHNER  
 33.406.10 - 33.431.25



Lanzenspitze  
 Lancet tip  
 Pointe lancéolaire  
 Punta lanceolar  
 Punte lanceolari

mm Ø	L = 310 mm
1,0	33.432.10
1,2	33.432.12
1,5	33.432.15
1,6	33.432.16
1,8	33.432.18
2,0	33.432.20
2,2	33.432.22
2,5	33.432.25

KIRSCHNER  
 33.432.10 - 33.432.25



STEINMANN Nägel  
 STEINMANN Pins  
 STEINMANN clous à os  
 STEINMANN clavos p. huesos  
 STEINMANN chiodi per ossa

L cm	
13	33.490.13
14	33.490.14
15	33.490.15
16	33.490.16
18	33.490.18
20	33.490.20
21	33.490.21

STEINMANN  
 33.490.13 - 33.490.21

## Exentionsbügel

Extension Bow  
Etriers à exention  
Estribos para extensión  
Archi per estensione

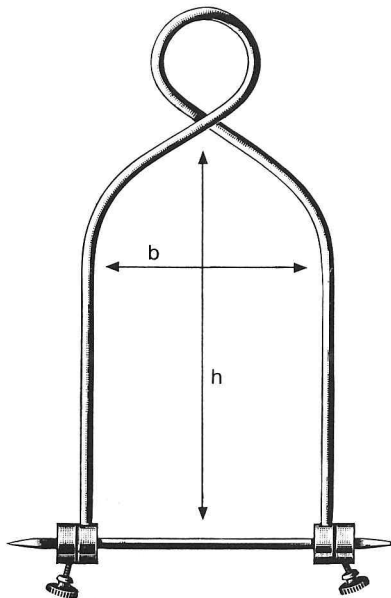

hxb cm	BOEHLER
16x 9	33.502.16
16x 11	33.502.21

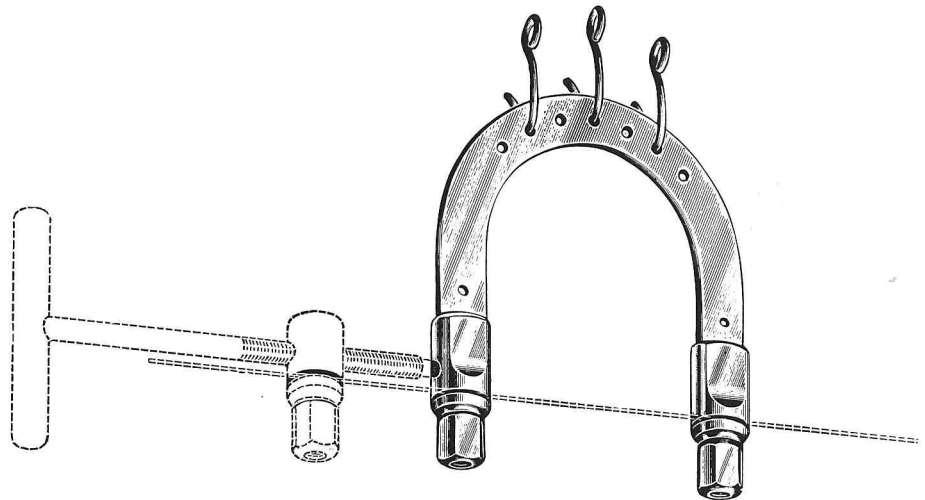

hxb cm	KIRSCHNER
6,0x 5,0	33.512.06
9,5x 7,0	33.512.09
10,5x 10,5	33.512.10
9,5x 11,0	33.512.11
12,0x 12,0	33.512.12
13,5x 13,0	33.512.13
15,5x 15,5	33.512.15
20,0x 15,5	33.512.20

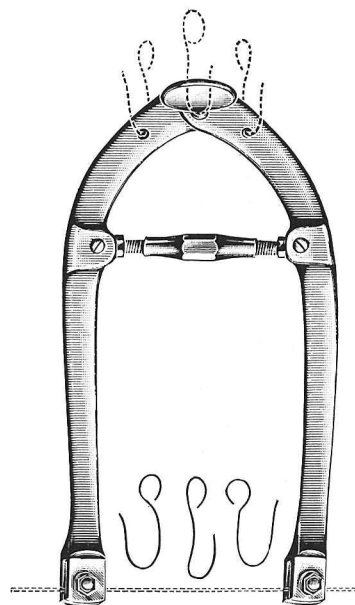

hxb cm	
18x 10	33.514.18
27x 16	33.514.27



33.515.01

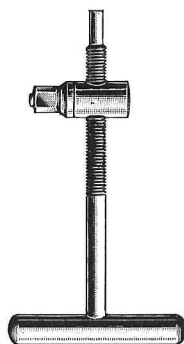

33.515.02

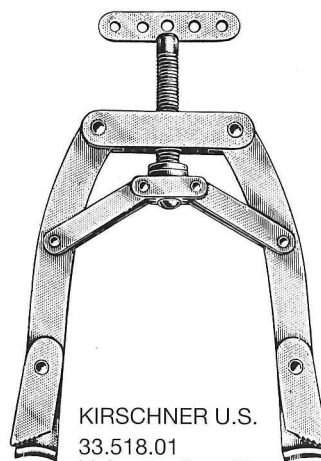

KIRSCHNER U.S.  
33.518.01  
klein · small · petit  
pequeño · piccolo  
33.518.02  
groß · large size  
grand · grande  
33.518.03  
extra groß · extra large size  
extra grand · extra grande

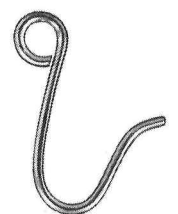

33.519.01

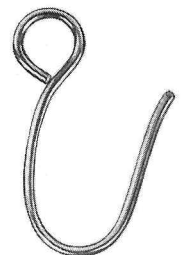

33.519.02

## Knochendraht und -Instrumente

Bone Wire and Instruments

Fil à os et instruments

Hilo para huesos e instrumentos

Filo per ossa e strumenti

**dimeda**<sup>®</sup>  
SURGICAL INSTRUMENTS

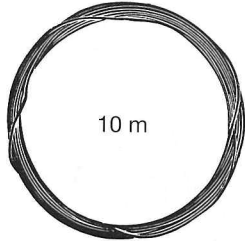

weich  
soft  
souple  
blando  
morbido

mm Ø

0,2	33.530.02
0,3	33.530.03
0,4	33.530.04
0,5	33.530.05
0,6	33.530.06
0,7	33.530.07
0,8	33.530.08
0,9	33.530.09
1,0	33.530.10
1,2	33.530.12
1,5	33.530.15



LOUTE  
33.531.21  
21 cm

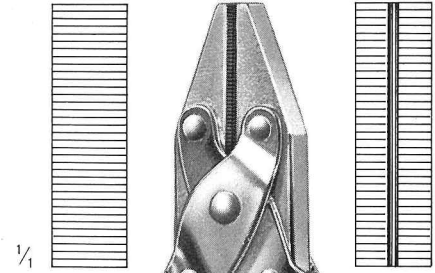

33.532.17  
17 cm

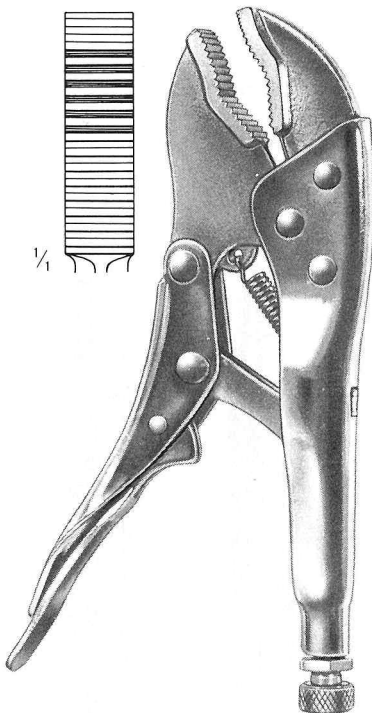

Grip  
33.533.18  
18 cm

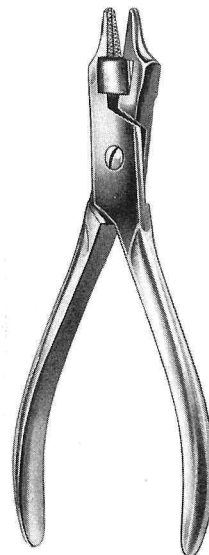

33.534.15  
15 cm

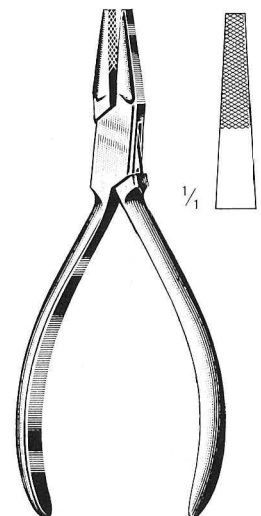
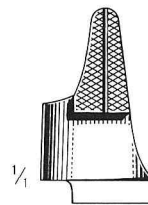

33.536.14  
14 cm

# Knochenchirurgie

Bone Surgery  
Chirurgie osseuse  
Ciurgia ósea  
Chirurgia ossea

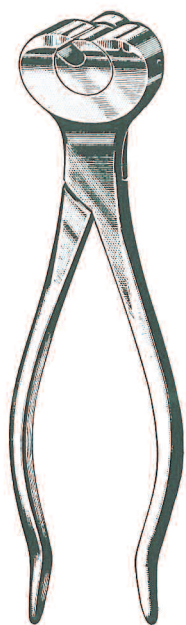

33.540.16  
16 cm

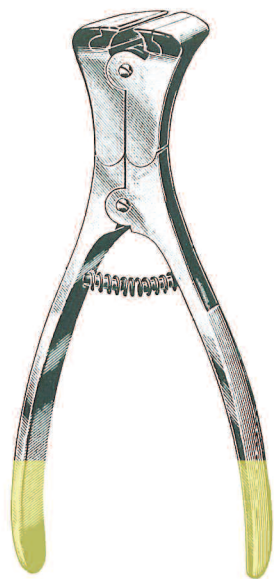

33.542.15  
15 cm

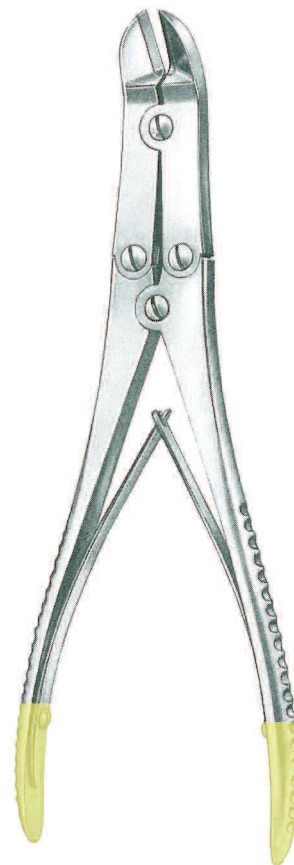

33.545.22  
22 cm



mm Ø	
2,4	33.560.24
3,2	33.560.32
4,8	33.560.48
6,4	33.560.64



33.562.24



33.562.32



33.562.48



33.562.64

f./p. Ø	2,4 mm	3,2 mm	4,8 mm	6,4 mm
---------	--------	--------	--------	--------

**Knochenagelung**  
 Bone Nailing  
 Enclouage des os  
 Enclavamiento de huesos  
 Inchioldamento di ossa

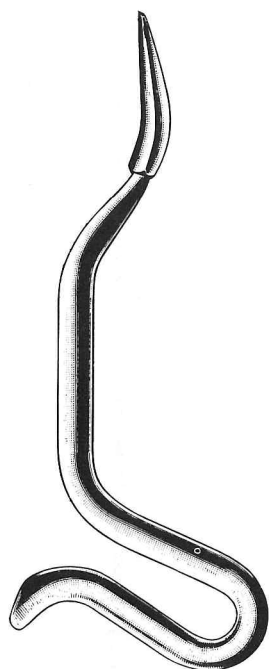

KUENTSCHER  
 33.571.26  
 26 cm



33.581.35-  
 33.585.60

mm Ø	L = 35 cm	L = 46 cm	L = 60 cm
2,5	33.581.35	33.581.46	
3,0	33.582.35	33.582.46	
3,5	33.583.35	33.583.46	33.583.60
4,0	33.584.35	33.584.46	33.584.60
5,0	33.585.35	33.585.46	33.585.60



KUENTSCHER  
 33.586.21  
 21 cm

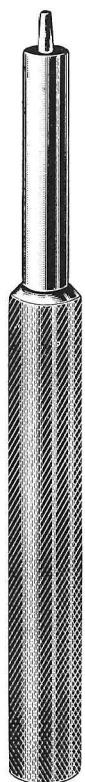

KUENTSCHER  
 33.588.21  
 21 cm

KUENTSCHER  
 33.573.35  
 35 cm

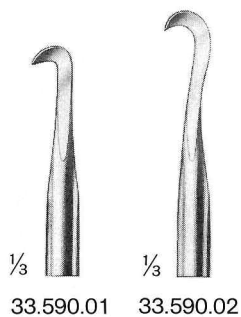

1/3  
 33.590.01

1/3  
 33.590.02

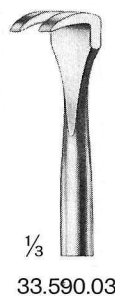

1/3  
 33.590.03



33.590.04



KUENTSCHER  
 33.590.00  
 63 cm

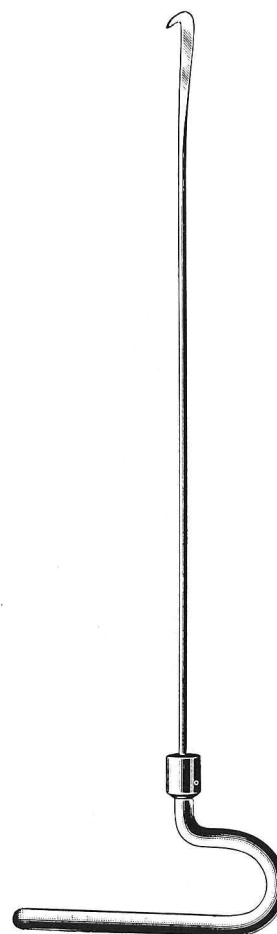

cm	
29	33.596.29
37	33.596.37
42	33.596.42
49	33.596.49

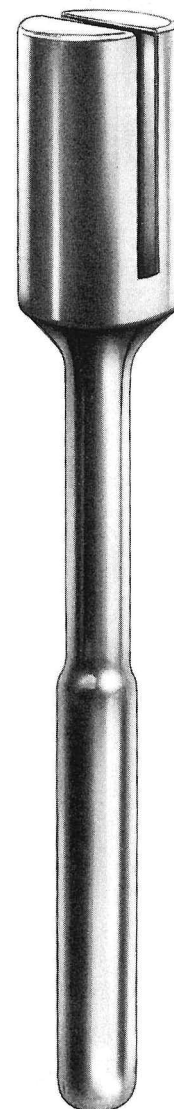

33.598.30

Orthopädie, Osteosynthese / Bone Surgery, Osteosynthesis / Chirurgie osseuse, Ostéosynthèse / Cirugía ósea, Osteosíntesi / Chirurgia ossea, Osteosintesi

## Instrumente zur Osteosynthese

Osteosynthesis Instruments

Instrumentos para osteosíntesis

Strumenti per osteosintesi

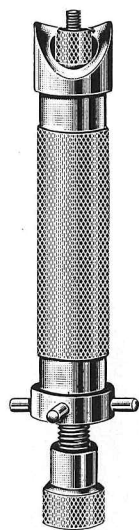

LLOYD  
33.602.20  
20 cm



LANE  
33.620.25  
25 cm

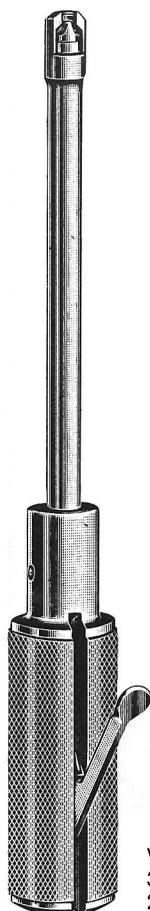

WILLIAMS  
33.624.24  
24 cm

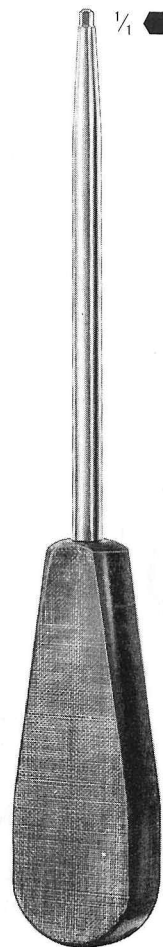

mm	
2,5	33.628.25
3,5	33.628.35

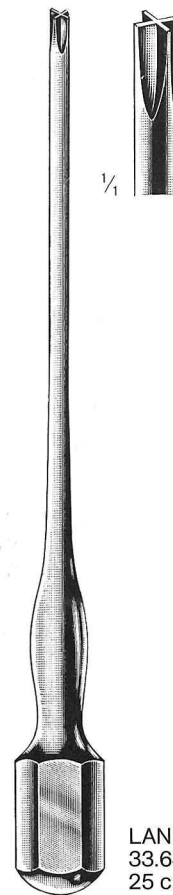

LANE  
33.632.25  
25 cm

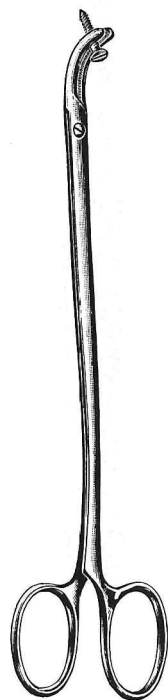

LANE  
33.635.18  
18 cm

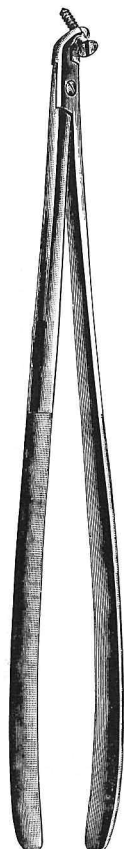

LANE  
33.637.23  
23 cm

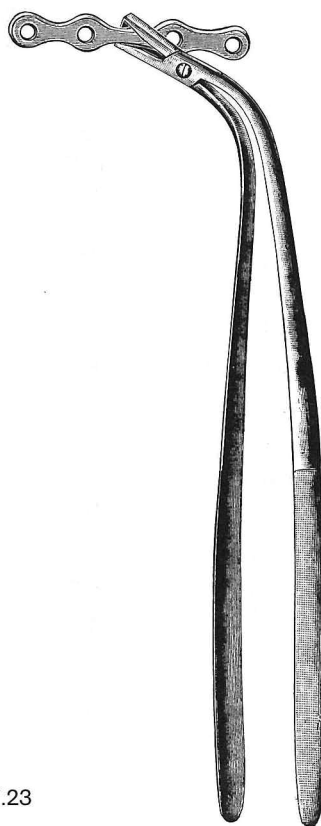

LANE  
33.639.22  
22 cm

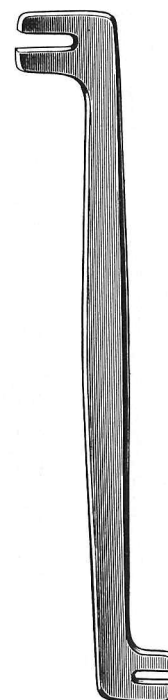

LANE  
33.640.18  
18 cm

## Instrumente zur Osteosynthese

Osteosynthesis Instruments  
Instruments pour ostéosynthèse  
Instrumentos para osteosíntesis  
Strumenti per osteosintesi

**dimeda**<sup>®</sup>  
SURGICAL INSTRUMENTS



**33.645.00**



**33.642.00**  
13 cm/5"



**33.643.01**  
14,5 cm/5½"



**33.643.01**  
14,5 cm/5½"



**33.650.14**  
13,5 cm/5¼"

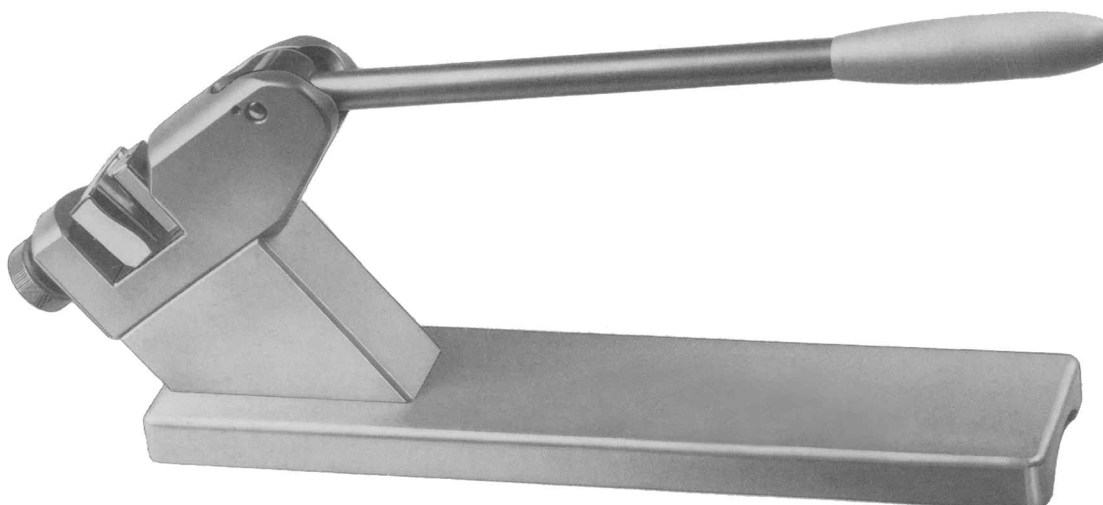

**33.670.00**

## Instrumente zur Osteosynthese

Osteosynthesis Instruments  
Instruments pour ostéosynthèse  
Instrumentos para osteosíntesis  
Strumenti per osteosintesi

Instrumentarium zum Einbringen von Hohlschrauben  
Instrument Set for Cannulated Screws  
Instrumentation pour l'application des vis à perforation longitudinale  
Instrumental para la aplicación de tornillos de perforación longitudinal  
Strumentario per viti cannulate



Ø mm	
4,5	33.802.45
7,0	33.802.70



33.810.05  
5 mm

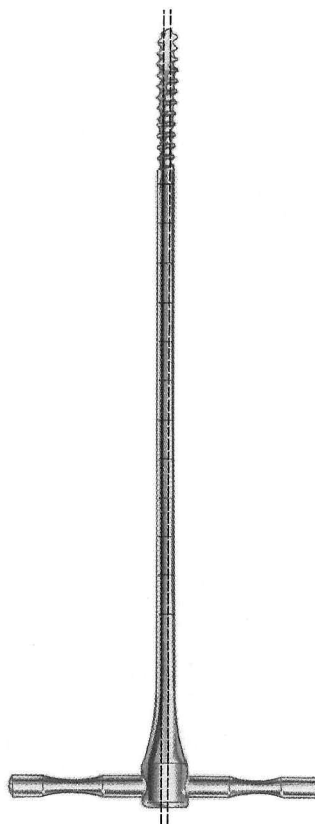

Ø mm	
4,5	33.812.45
7,0	33.812.70

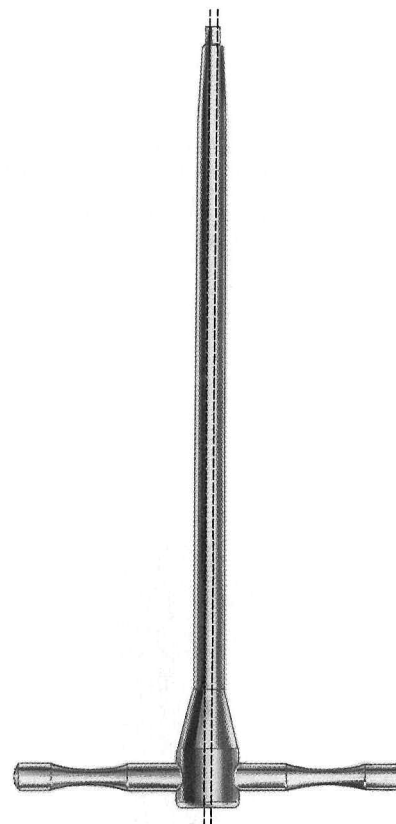

Ø mm	
2,5	33.816.25
3,5	33.816.35
5,0	33.816.50

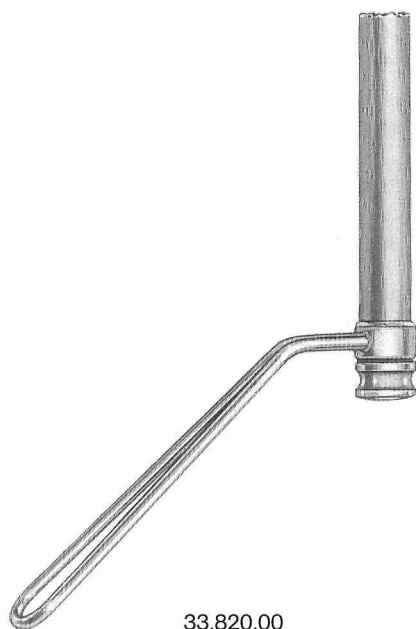

33.820.00